

**TRAFFIC STUDY FOR  
ONE NORTH WASHINGTON PLACE  
BATAVIA, ILLINOIS**

December 2, 2016

Prepared for:

**The City of Batavia**

Prepared by:



**JAMES J. BENES AND ASSOCIATES, INC.**  
950 Warrenville Road, Suite 101  
Lisle, Illinois 60532  
(630) 719-7570

**TABLE OF CONTENTS**

A. Introduction..... 1

B. Existing Conditions..... 2

C. Site Traffic Generation..... 5

D. Site Traffic Distribution and Assignment..... 5

E. Non-Site Traffic..... 7

F. Traffic Operations Analysis..... 7

G. Summary of Findings and Recommendations..... 12

APPENDIX

## A. INTRODUCTION

Shodeen Construction is proposing to redevelop about three quarters of the block bounded by Wilson Street, State Street, N. River Street and N. Washington Avenue (IL Route 25) in the Batavia central business district. Four existing buildings will be razed and existing parking lots along the south side of State Street will be removed to make way for the new land uses. The location of the redevelopment site is illustrated below.



According to the One North Washington Place Site Context Plan, prepared by Nagle Hartray Architecture and dated June 30, 2015, the proposed development will consist of a four floor mixed use building containing 171 apartment units, 14,650 square feet of retail space, and a two level parking garage with about 304 parking spaces. One curb cut will be removed on each of Wilson Street, N. River Street and N. Washington Avenue. Two curb cuts will be provided on State Street, one servicing each level of the parking garage. It is understood that parking supply has been analyzed separately, and is therefore not discussed in this study.

The planned development uses are intended to be complementary with existing downtown uses, with the goals of enhancing the vibrancy of the downtown, encouraging the use of alternate modes of transportation including walking, bicycling and transit, and reducing personal automobile trips by residents of the development.

This report contains existing traffic volume and operation information, expected trip generation from the site and an analysis of future traffic conditions after construction of the proposed redevelopment. The focus of this study is on traffic operations at the intersections along Wilson Street from North River Street to North Washington Avenue, which experiences high traffic volumes during peak hour traffic periods.

## **B. EXISTING CONDITIONS**

A field reconnaissance was conducted of the site vicinity to collect information on the existing road network, including traffic control devices, lane configurations, and existing traffic volumes. Existing land uses surrounding the site were also noted.

### ***Surrounding Land Uses***

The proposed redevelopment site is located in the City of Batavia's central business district. Land uses adjacent to or across the perimeter streets are primarily commercial uses including several restaurants, a vacant gas station, dance studio, salon/spa, a bank, and service oriented uses. Commercial uses extend farther east and west along Wilson Street including the Batavia Plaza shopping center west of the Fox River. Land uses transition to residential uses north, east and south of the site.

### ***Public Transit and Pedestrian/Bicycle Facilities***

Downtown Batavia is served by Pace Bus Route 802, providing access to the UP West and the BNSF Metra commuter stations in Geneva and Aurora respectively. This route also serves Waubensee Community College, Presence Mercy Medical Center, Delnor Community Hospital and the Kane County Judicial Center.

The nearest Pace stop is located at the intersection of West Wilson Street and Batavia Avenue, about 1/3<sup>rd</sup> of a mile from the redevelopment site. The site is located within the Pace 596 Call-n-Ride service area.

The Fox River Trail is located half of a block west of the site along the both sides of the Fox River. A pedestrian/bicycle bridge crosses the river just north of State Street providing pedestrian and cyclist access to the Batavia Riverwalk and the west bank portion of the Fox River Trail.

### ***Surrounding Roadways***

The following is a brief description of roadways in the immediate site vicinity. Figure 1 (Existing Traffic Control Devices and Travel Lanes) in the Appendix provides a diagram of existing roadway conditions.

#### **Wilson Street**

Wilson Street is a two-way, two lane east-west roadway, with a posted 25 mph speed limit in the vicinity of the site. Auxiliary turn lanes are provided at various intersections as described below. Parking lanes are provided on both sides of Wilson Street in the site vicinity.

Wilson Street is an arterial street under the jurisdiction of the City with the exception of the section from South River Street to North Washington Avenue which is designated IL Route 25, and is under the jurisdiction of the Illinois Department of Transportation (IDOT).

The Wilson Street intersection with South River Street is under traffic signal control. The eastbound and westbound approaches to the intersection each have a lane shared by through and right turn traffic movements and a separate left turn lane.

At its intersection with South Washington Avenue, Wilson Street has a wide single lane shared by through and right turn traffic movements on the eastbound approach and a wide single lane shared by through and left turn movements.

On the westbound approach, the pavement is wide enough for through traffic movements to bypass any vehicles waiting to turn left to South Washington, which allows the westbound approach to function as if a separate left turn lane was provided.

The Wilson Street intersection with N. Washington Avenue is under traffic signal control, and has separate lanes for through and left turn movements on the eastbound approach, and separate through and right turn lanes on the westbound approach.

### North River Street

North River Street is a two-way, two lane north-south local street under City jurisdiction. The block adjacent to the redevelopment site is designed as a pedestrian friendly environment without delineation of boundaries between pedestrian and vehicular travel space. On street parking is prohibited along this block with the exception that four parking spaces are available just south of State Street. The posted speed limit is 20 mph.

On its southbound approach to Wilson Street, N. River Street is under stop sign control. Only right turns are permitted onto Wilson. Through traffic movements to S. River and left turns to Wilson Street are prohibited.

### South River Street (IL Route 25)

South River Street is a two-way, two lane north-south arterial street under IDOT jurisdiction. On street parking is prohibited on S. River Street. The posted speed limit is 30 mph.

On its northbound approach to the traffic signal controlled intersection with Wilson Street, S. River Street has two travel lanes. The left lane is marked as a left turn lane, but is used by vehicles making left turns onto westbound Wilson Street and by vehicles making the small jog west to proceed north on N. River Street. The east lane serves as an exclusive right turn lane.

### South Washington Avenue

South Washington Avenue is a two-way, two lane north-south local street under City jurisdiction. On street parking is prohibited on the block of S. Washington south of Wilson Street. The regulatory speed limit is 30 mph.

On its approach to Wilson Street, S. Washington is under stop sign control. Its single northbound lane is shared by left and right turn traffic movements.

### North Washington Avenue (IL Route 25)

North Washington Avenue is a two-way, two lane north-south arterial street under IDOT jurisdiction. On street parking is prohibited adjacent to the redevelopment site. The posted speed limit is 30 mph.

On its southbound approach to the traffic signal controlled intersection with Wilson Street, N. Washington Avenue has separate left and right turn lanes.

### ***Existing Traffic Volumes***

Manual weekday morning and evening peak hour traffic counts were conducted at the intersections of South and North Washington Streets with Wilson Street, and River Street with Wilson Street.

The traffic counts were performed on Tuesday October 25 and Thursday October 27, 2016. Turning movements were recorded in 15 minute increments from 7:00 to 9:00 AM and from 4:00 to 6:00 PM. The counts included recording vehicle type and pedestrian volumes.

Existing peak hour traffic volumes are shown on Figure 2 in the Appendix. Summaries of traffic counts are also provided in the Appendix.

Counted traffic volumes departing one intersection do not exactly match the volumes arriving at the other intersection because the traffic counts at River Street and at Washington Avenue were performed on different days. There is always some day to day variation in traffic volumes. Multi-day traffic counts are not uncommon. It is accepted practice to adjust the lower of arriving or departing traffic volumes upward to balance the traffic flow between the intersections. The study analyses are thus based on the higher of the two days of counted traffic.

There is some variation in the times of the individual intersection peak hours. The fifteen minute increment traffic count data for all of the intersections were reviewed, and the peak hours for the Wilson Street corridor were determined to occur from 7:15 to 8:15 am and from 4:45 to 5:45 pm. The corridor peak hour traffic volumes, adjusted as previously discussed, were used in the analyses.

Batavia High School, located 1.25 miles west of the proposed development, generates traffic on Wilson Street. First bell at the school is at 7:35 am. The vast majority of morning high school traffic occurs 15 to 20 minutes before the first bell, therefore the morning school peak traffic period is accounted for in the traffic analyses. The end of school day is 2:30 pm, considerably offset from the commuter peak traffic period. After school activities spread out the traffic leaving school, and lower the end of school the peak traffic volume. Consequently, the evening peak traffic hour along Wilson Street, which includes commuters and some after school trips, is higher than at the end of classes.

### C. SITE TRAFFIC GENERATION

Peak hour traffic volumes generated by the proposed land uses were estimated using trip generation rates contained in Trip Generation Manual, 9<sup>th</sup> Edition, published by the Institute of Transportation Engineers (ITE).

Recognizing that there are trip reduction benefits for closely spaced complimentary land uses, the ITE Trip Generation Handbook provides procedures for estimating trip reductions for Mixed-Use developments and also for Urban Infill/Redevelopment. Use of straight ITE trip generation rates for individual land uses in a setting like downtown Batavia does not account for the synergy between the different land uses. Without detailed information on surrounding land use types and sizes, there is insufficient data to use the Mixed-Use methodology to account for trip reductions that can result due to walking or biking trips between the redevelopment site and nearby land uses.

The Urban Infill/Redevelopment methodology was used instead. The ITE Handbook provides data for mode of transportation share (personal vehicle, transit, walk and bike) based on studies performed nationwide for use when employing the Urban Infill/Redevelopment method. The site trips estimated using the ITE method yielded a 27% trip reduction in the evening peak hour based on the national surveys. Upon review of the analysis, it is our opinion that the available national study data likely overstates vehicle occupancy, transit and walk/bike trips for the Batavia redevelopment site. Instead, we elected to independently estimate site trip reduction for the *apartments only* based on the most recent available US Census data for the City of Batavia.

US Census commuting data for the city as whole indicates that 7% of residents work at home, 3% travel to/from work using public transit and 2% walk or bike. It is our opinion that the downtown business district location of the redevelopment encourages walking and transit trips, and likely will result in fewer personal vehicle commuter trips for downtown Batavia residents in comparison to the average for the entire City population. Nonetheless, we conservatively used the citywide averages.

The ITE land use type "Mid-Rise Apartments" (ITE Code 223) most closely matches the proposed apartment use. It was noted that ITE trip generation data for this use was collected in the late 1980's, before on-line shopping, banking, video rentals, etc. became as prevalent as it is today. With the boom in ecommerce along with greatly improved electronic connectivity, and greater emphasis on non-personal motor vehicle modes of travel over the past decade, it is our opinion that some reduction in the Mid Rise apartment trip generation is also warranted to account for reductions in *non-commute trips*. Additionally, the ITE trip generation rates do not account for vehicular trip reductions due to walking trips between complementary land uses in the redevelopment area. Accordingly a total reduction to the ITE trip generate rate based apartment trips of 15% (12% City of Batavia non-personal vehicle commuter trips plus 3% walkability and/or shared trips between downtown land uses) was used for this study.

It is our opinion that the 15% adjustment used to estimate apartment site trips is reasonable and appropriate for this study. We also note that conservatively, no trip reductions were applied to the retail use trip generation.



The proposed retail space consists of two small spaces of 6,300 and 8,350 square feet each. The ITE Specialty Retail land use (Code 826) best matches and is appropriate for the proposed retail than the Shopping Center land use (Code 820). Specialty retail uses typically do not open until after the morning street peak hour, ITE does not provide morning street peak hour period trip generation rates for this land use category. Morning retail site trips were estimated using the ITE trip generation rates for a Shopping Center (Code 820), *conservatively* assuming that some stores could open during the morning peak hour.

Projected site peak hour trips are summarized below and shown on Figure 3 in the Appendix.

PROJECTED SITE TRIPS						
	AM Peak Hour			PM Peak Hour		
	Enter	Exit	Total	Enter	Exit	Total
<b>171 Mid-Rise Apartments</b>						
ITE Land Use Code 223	18	39	57	41	30	71
15% Trip Reduction	-3	-6	-9	-6	-5	-11
<b>Total Apartment Trips</b>	<b>15</b>	<b>33</b>	<b>48</b>	<b>35</b>	<b>25</b>	<b>60</b>
<b>14,645 s.f. Retail</b>						
ITE Land Use Code 820 (Shopping Ctr.)	30	18	48	-	-	-
ITE Land Use Code 826 (Specialty Retail)	-	-	-	25	32	57
<b>Total Retail Trips</b>	<b>30</b>	<b>18</b>	<b>48</b>	<b>25</b>	<b>32</b>	<b>57</b>
<b>Apartment + Retail</b>						
<b>Total Site Trips</b>	<b>45</b>	<b>51</b>	<b>96</b>	<b>60</b>	<b>57</b>	<b>117</b>

#### D. SITE TRAFFIC DISTRIBUTION AND ASSIGNMENT

Several factors influence the directions to and from which development traffic will travel on adjacent streets. The estimated trips entering and exiting the site were distributed to the surrounding road network based upon a review of the existing road network, the site access driveways, existing traffic patterns in the site vicinity and the relative ease or difficulty of travel routes to and from the site. The distribution of site traffic is shown in the following table.

Directional Distribution of Site Trips	
Direction of Travel to/from	Percent of Site Trips
West on Wilson Street	35%
South on S. River St. (IL-25)	20%
East on Wilson Street	30%
North/East on N. Washington/State	15%
<b>TOTAL</b>	<b>100%</b>



## E. NON-SITE TRAFFIC GROWTH

Buildout of the redevelopment is projected to be completed in 2019. A future conditions analysis year of 2024 (time of completion plus 5 years) was selected to account for the period between opening and full occupancy of the development.

Future non-site traffic volumes were increased to account for normal growth of non-site (background) traffic due to ongoing regional and local development. The Chicago Metropolitan Agency for Planning (CMAP) provides population, households and employment projections to Year 2040 for the Chicago metropolitan area. The CMAP projections for the City of Batavia and adjacent surrounding communities were used as the basis to estimate the background traffic growth of existing non-site traffic. A growth rate of 1% per year was used to estimate non-site background traffic at year 2024. See Figure 4 in the Appendix.

## F. TRAFFIC OPERATIONS ANALYSES

### *Intersection Capacity Analyses*

Traffic operations at the development area intersections were analyzed under Existing conditions and year 2024 full occupancy (Total Traffic).

The analysis of existing conditions reflects traffic volumes, intersection traffic control devices and numbers of traffic lanes that currently exist on the area streets.

Total traffic conditions represent the anticipated design year traffic conditions including existing traffic, normal growth of existing traffic, plus additional traffic generated by the site redevelopment. See Figure 5 in the Appendix.

Traffic operations were evaluated using the procedures contained in the Highway Capacity Manual (HCM) published by the Transportation Research Board. Analyses were performed using the HCS 2010 software for analysis of unsignalized intersections.

The signalized intersections at River Street and at N. Washington Avenue are part of an interconnected traffic signal system along Wilson Street that also includes the intersection at Island Avenue. Due to the close proximity to the stop sign controlled N. River Street and South Washington Avenue approaches to Wilson Street, Synchro Version 9 analysis software was used to model the signal system.

The accepted way traffic engineers evaluate intersection performance is with the average length of time an approaching vehicle is delayed before crossing an intersection measured in seconds per vehicle. This is considered a more accurate metric of operation than determining the projected length of queues approaching an intersection, even if it is less visible to those waiting in line. The length of queues is important in evaluating the space provided for motorists to wait. Delay and queuing will be discussed in this report

Intersection Level of Service (LOS) is represented by the letter grades A (best) through F (worst). Design guidelines contained in the IDOT design manuals specify a minimum LOS "C" for minor arterials but a LOS "D" "may be used in heavily developed sections of metropolitan

areas". A LOS "D" is acceptable for collector and local streets. Wilson Street, North Washington Avenue and South River Street are designated minor arterials.

For all-way stop controlled intersections and signalized intersections, an overall intersection LOS is computed. For two-way stop controlled intersections, delay and LOS are computed only for traffic movements that are under stop control and those movements that must yield to opposing traffic.

The LOS at an intersection as defined in the Highway Capacity Manual is summarized in the following table.

HCM Level of Service Criteria		
	Signalized Intersections	Unsignalized Intersections
Level of Service	Average Control Delay (seconds/vehicle)	Average Control Delay (seconds/vehicle)
A	≤ 10	≤ 10
B	> 10 and ≤ 20	> 10 and ≤ 15
C	> 20 and ≤ 35	> 15 and ≤ 25
D	> 35 and ≤ 55	> 25 and ≤ 35
E	> 55 and ≤ 80	> 35 and ≤ 50
F	> 80	> 50

The average control delay is the delay is experienced by a vehicle passing through the intersection, including stopped delay as well as time lost decelerating when approaching the intersection and accelerating when leaving the intersection. It is the *average* delay for the specified traffic movement, street approach or intersection as a whole. For intersection approach and overall intersection, the delay is the weighted average for all traffic movements. Because these are *average delays*, the actual delay experienced by any individual driver will vary.

**Stop Sign Controlled Intersections**

North River Street/Wilson Street Intersection

The stop sign controlled North River Street approach to Wilson Street currently operates at an acceptable Level of Service (LOS) "C" during both the morning and evening weekday peak hour periods. Under year 2024 projected Total Traffic conditions with full occupancy of the proposed mixed use development, the intersection will continue to operate at an acceptable LOS "C".

Under existing and future traffic conditions, the 95<sup>th</sup> percentile queuing on the southbound North River Street approach is one vehicle. The 95<sup>th</sup> percentile queue is the length of queued vehicles that would *not* be exceeded during 95% (57 minutes) of the peak hour period. In other words, the total duration of queues in excess of one vehicle is projected to occur for only 3 minutes during the peak hour.

A summary of the stop sign controlled intersection analyses is provided below.

STOP SIGN CONTROLLED INTERSECTIONS CAPACITY ANALYSIS RESULTS <sup>①</sup>						
Intersection	Scenario	Peak Hour	Intersection Approach/Lane Configuration			
			Eastbound	Westbound	Northbound	Southbound
North River/Wilson			Signalized	<sup>②</sup>	N/A	R
	Existing	AM	--	--	--	C - 1
		PM	--	--	--	C - 1
	2024 Total Traffic	AM	--	--	--	C - 1
PM		--	--	--	C - 2	
S. Washington/Wilson			<sup>②</sup>	L	shared L/R	N/A
	Existing	AM	--	B - 0	D - 1	--
		PM	--	A - 0	C - 1	--
	2024 Build Total Traffic	AM	--	B - 0	D - 1	--
PM		--	A - 0	D - 1	--	

<sup>①</sup> L or R = exclusive left or right turn lane. T = exclusive through lane. Shared L/T/R indicates the designated traffic movements share a lane. "B - 1" indicates the letter grade for the operations of the approach and the number of vehicles in the 95<sup>th</sup> percentile queue on the intersection approach. A value of 0 indicates the computed 95<sup>th</sup> percentile queue of stopped vehicles is less than 0.3 vehicles.

<sup>②</sup> Traffic movements on this approach do not stop or yield to conflicting traffic, therefore no LOS grade is provided.

South Washington Avenue/Wilson Street Intersection

The stop sign controlled northbound approach to Wilson Street currently operates at LOS "D" during the morning peak hour, and at LOS "C", less than one second delay short of "D" during the evening peak hour. Upon full occupancy of the proposed development, the evening peak hour LOS drops to level "D", and the morning peak hour will remain at LOS "D". The left turn movement from Wilson Street currently operates at, and will continue to operate at acceptable LOS "B" during the morning and LOS "A" during the evening peak hours upon full occupancy of the proposed development. The 95<sup>th</sup> percentile queues on the S. Washington approach and for the west to southbound left turn movement were one vehicle length or less with the exception that the northbound queue increases to two vehicles during the evening peak hour under year 20204 Total traffic conditions.

This intersection is located 100 feet west of the signalized N. Washington/Wilson intersection. The left turn lane on the eastbound approach to North Washington Avenue extends through the S. Washington intersection. Vehicles entering and exiting S. Washington must cross the eastbound left turn lane for N. Washington. Left turn movements at this intersection were very low during peak periods.

It was observed that vehicle queues on the eastbound approach to N. Washington frequently extended west past S. Washington. Eastbound drivers sometimes left a gap to allow vehicles to turn left to and from S. Washington. When no gap was provided, vehicles turning left from S. Washington waited in the westbound Wilson through lane.

Westbound Wilson Street does not have a separate left turn lane at S. Washington Avenue. The westbound lane however, is 16 feet wide at the intersection. During the peak traffic hours, it was observed that in most cases, queued vehicles waiting to turn left to S. Washington did not block westbound traffic flow because the wide lane allowed through traffic to bypass the stopped vehicles.

### ***Traffic Signal Controlled Intersections***

#### ***South River Street/Wilson Street Intersection***

The signalized S. River Street intersection with Wilson Street currently operates, and will continue to operate at an acceptable LOS “C” during the weekday morning peak hour, with or without the redevelopment. The existing eastbound through/right turn lane 95<sup>th</sup> percentile queue approaches the intersection at Island Avenue. This queue is projected to increase by two vehicles under the projected Total Traffic conditions. Changes in 95<sup>th</sup> percentile queueing on all other approaches have minimal impact. All year 2024 Total Traffic individual traffic movements LOS remain unchanged from the existing conditions LOS during the morning peak hour.

During the existing evening peak hour, the S. River Street/Wilson Street intersection operates at an overall LOS “D”. However, the eastbound approach operates at less than acceptable LOS “E”, with the 95<sup>th</sup> percentile queue extending west from River Street through the intersection at Island Avenue. The remaining traffic movements operate at an acceptable LOS “D” or better. It is noted that queuing on the westbound approach was observed to frequently extend to N. Washington Avenue.

Under the 2024 Total Traffic scenario, the eastbound approach LOS is projected to drop to LOS “F”, with an increase in queuing of about 7 vehicles during the evening peak hour. The westbound approach left turn movement is projected to decline from LOS “D” to “E” with an increase in queuing of about 5 vehicles. Overall, the intersection will still remain at LOS “D”.

A 2024 No-Build scenario analysis was performed for the evening peak hour to evaluate the intersection with normal background traffic growth and without redevelopment generated traffic growth. Background growth alone causes 98% of the projected additional eastbound delay in the 2024 Build scenario. The increase in eastbound delay and queueing due to the mixed use redevelopment is minimal. Since there is no change in LOS during the morning peak hour from Existing to 2024 Total Traffic conditions, the morning peak hour was not evaluated for the No Build scenario.

Only 29% of the increase in westbound left turn delay and drop in LOS from “D” to “E” results from the mixed use redevelopment. The major contributing factor to the increase in westbound left turn movement delay is also background traffic growth.



North Washington Street/Wilson Street Intersection

Overall, the signalized N. Washington Avenue intersection with Wilson Street currently operates, and will continue to operate at an acceptable LOS “B” during the weekday morning and evening peak hours, with or without the redevelopment. The maximum projected increase in 95<sup>th</sup> percentile queuing from Existing to year 2024 Total Traffic conditions for any traffic movement is one vehicle on the eastbound approach during the morning peak hour, and one vehicle on the westbound approach during the evening peak hour.

All individual traffic movements at this intersection operate at an acceptable LOS “D” or better, with the exception of the southbound Washington to eastbound Wilson left turn movement which operates at LOS “E” under Existing and year 2024 Total traffic conditions. The long delays on the southbound approach result from the majority of green signal time being assigned to the Wilson Street approaches. During the morning peak hour 81% of the signal cycle was allocated to the Wilson Street approaches and 74% was allocated during the evening peak hour. The total increase in delay experienced by drivers from existing to Total Traffic conditions is 2 additional seconds.

The proposed mixed use development is projected to have minimal impact on traffic operations at the N. Washington Avenue intersection with Wilson Street.

SIGNALIZED INTERSECTIONS CAPACITY ANALYSIS RESULTS <sup>①</sup>							
Intersection	Scenario	Peak Hour	Overall Intersection LOS	Intersection Approach, Lane Configuration & LOS <sup>②</sup>			
				East bound	West bound	North bound	South bound
<b>South River St. &amp; Wilson St.</b>				L & T/ R	L & T/R	L/T & R	Stop Sign
	Existing	AM	C	C	B	C	
		PM	D	E	C	C	
	2024 No Build	AM	--	--	--	--	--
PM		D	D	F	C	C	
2024 Total Traffic	AM	C	C	C	B	C	
	PM	D	D	F	C <sup>(4)</sup>	C	
<b>N. Washington Ave. &amp; Wilson St.</b>				L & T/R	L & T & R	No South Leg	L & T & T/R
	Existing	AM	B	A	A		B
		PM	B	B	A	A	
2024 Total Traffic	AM	B	B	A	A		C
	PM	B	B	A	B		C <sup>(3)</sup>

① L or R = exclusive left or right turn lane. T = exclusive through lane. L/T/R indicates the designated traffic movements share a lane.  
 ② LOS letter grade provided is the overall approach LOS.  
 ③ Southbound approach left turn lane operates at LOS E.  
 ④ Westbound approach left turn lane operates at less than 1 second of delay from LOS E under No Build, and is projected to operate at LOS E under Build scenario.

## G. SUMMARY OF FINDINGS AND RECOMMENDATIONS

The proposed One North Washington Place is a mixed use redevelopment of about  $\frac{3}{4}$  of the block bounded by North River Street, North Washington Street, State Street and Wilson Street in the City of Batavia's central business district. Access to the development will be provided via two driveways to State Street.

Wilson Street and IL Route 25 (N. Washington, S. River and Wilson between the two) are both minor arterial streets. Wilson Street in particular experiences high peak hour traffic volumes and queuing of vehicles during the weekday morning and evening peak hour periods. About 85% of the vehicular traffic generated by the development is projected to travel on Wilson Street. Accordingly an evaluation of the traffic impacts of the proposed development was performed for the section of Wilson Street from North River Street to North Washington Street.

Traffic analyses were performed for the following scenarios:

- Year 2016 Existing Conditions
- Year 2024 Total Traffic Conditions (under full occupancy of the redevelopment site)

Additional traffic analyses were performed during the evening peak for the South River Street/Wilson Street intersection under a Year 2024 No Build scenario to evaluate the intersection with normal background traffic growth and without redevelopment generated traffic growth.

The following is a summary of the findings and recommendations of this traffic study:

1. The stop sign controlled **North River Street** approach to Wilson Street will be minimally impacted by the proposed redevelopment. The current acceptable intersection Level of Service (LOS) will not change and there will be minimal change in vehicular queuing on the N. River Street approach to Wilson Street.
2. The overall operation of the traffic signal controlled approaches to the **South River Street/Wilson Street** intersection are at an acceptable LOS "D" or better during the weekday morning and evening peak hour periods. However the eastbound approach, specifically the eastbound through traffic movement, currently operates at a less than acceptable LOS "E" during the evening peak hour, and is projected to decline to LOS "F" under the 2024 Total Traffic scenario which includes development traffic. The eastbound approach currently experiences long queues during the peak hours, which can extend west of the Island Avenue/Wilson Street intersection. Eastbound queuing is projected to increase under Year 2024 Total Traffic conditions. The westbound approach left turn traffic movement is projected to experience a drop in LOS from "D" to "E" with increased queuing during the evening peak hour period.

A Year 2024 No-Build scenario was performed to evaluate the intersection during the evening peak hour with normal background traffic growth and without the proposed redevelopment. The evaluation of the No-Build scenario demonstrated that the increase in delay and queuing due to the mixed used redevelopment is minimal. The increases in delay and queuing, and decline in LOS is due primarily to the normal background growth of traffic on area streets.

3. The stop sign controlled **South Washington Avenue** approach to Wilson Street will be minimally impacted by the proposed redevelopment. Few vehicles turn to and from S. Washington Avenue during the peak hour periods.
4. The overall operation of the traffic signal controlled approaches to the **North Washington Avenue/Wilson Street** intersection are at an acceptable LOS "B" or better during the weekday morning and evening peak hour periods. During the evening peak hour under existing and Total Traffic conditions, the southbound approach left turn movement operates at LOS "E" due to the long green signal time assigned to serve the much larger east-west traffic volumes. New traffic generated by the proposed redevelopment will have minimal impact in operations and queuing at this intersection.
5. The traffic analyses indicate that ***the proposed redevelopment will have a low impact on traffic operations on the Wilson Street corridor.*** The primary cause of declines in LOS and increases in queuing at the intersections is the normal background growth of non-site traffic. Recognizing that long vehicular queues and less than acceptable Levels of Service currently exist for certain traffic movements we recommend consideration of the following actions.
  - a. As should be done with any coordinated traffic signal system, a periodic review of traffic signal timings along the Wilson Street corridor should be performed. Traffic patterns change over time, and it is good practice to periodically review and adjust system timings to optimize operations under ever changing conditions.
  - b. The proximity of a variety of land uses in district the can contribute to reductions in personal vehicle trips and increases in walking, bicycle and transit trips. To further the potential for personal vehicle trip reductions, we suggest the following:
    - i. Encourage downtown development or redevelopment with land uses complementary to the proposed residential component, such as local grocery stores, that can create a synergy between the uses and reduce vehicular trips.
    - ii. Investigate the possibility of adding or changing the Pace bus routes to provide regular and more convenient service to the portion of downtown east of the Fox River.





--End--

**APPENDIX**





SCALE: Not To Scale

- LEGEND**
-  TRAFFIC SIGNAL
  -  STOP SIGN
  -  EXISTING TRAVEL LANES
  - 25 MPH POSTED SPEED LIMIT
  -  EXISTING MARKED CROSSWALK
  - OR
  -  CROSSWALK

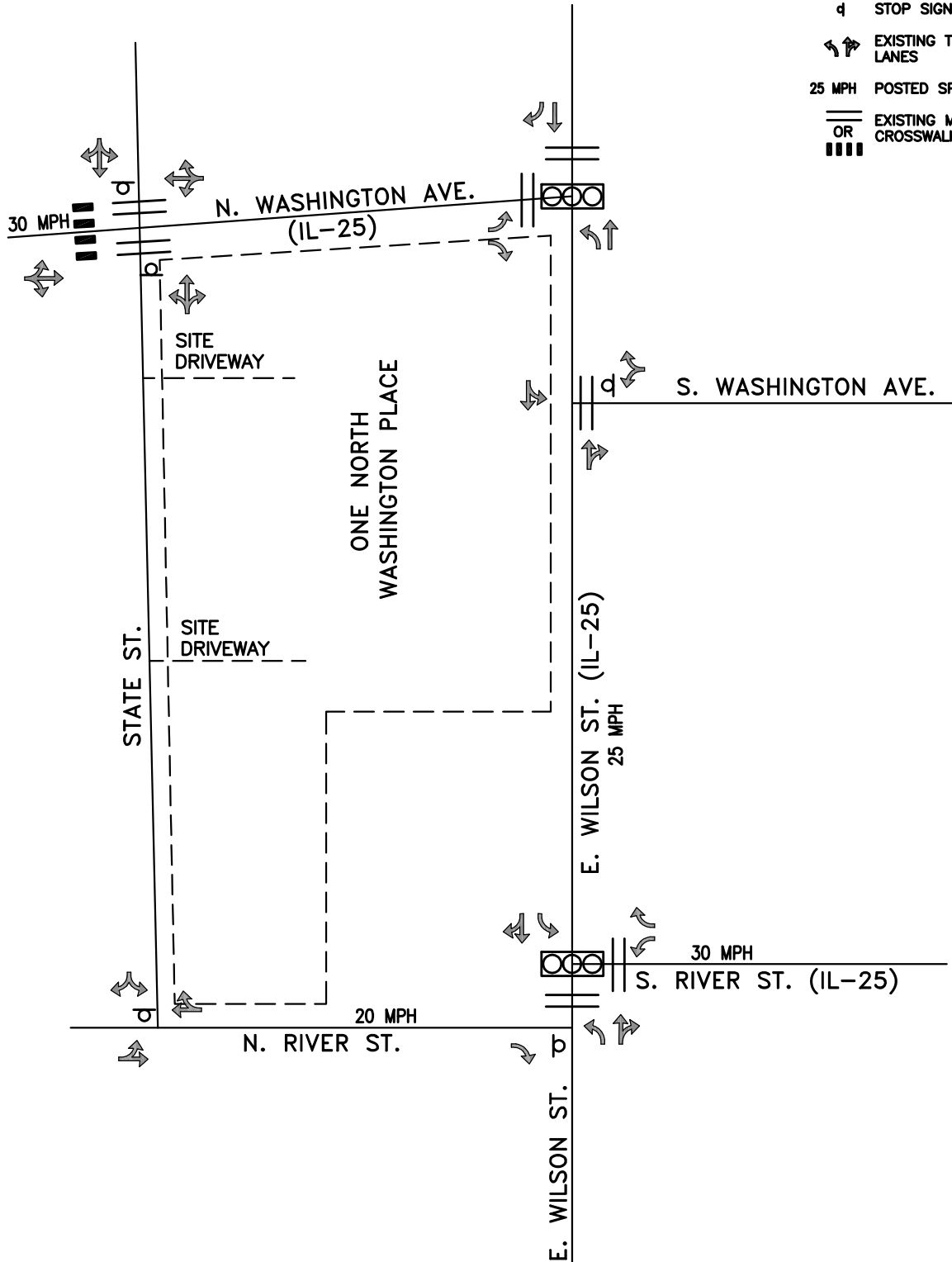

JAMES J. BENES & ASSOCIATES, INC.  
 950 Warrenville Road, Suite 101, Lisle, Illinois 60532  
 Tel. (630) 719-7570 · Fax (630) 719-7589

EXISTING TRAFFIC CONTROL DEVICES AND TRAVEL LANES

FIGURE 1

SCALE: Not To Scale

**LEGEND**

XX AM PEAK 7:15-8:15 AM  
 (XX) PM PEAK 4:45-5:45 PM

\*RAW COUNT VOLUMES WERE  
 INCREASED TO BALANCE  
 THROUGH TRAFFIC TOTALS

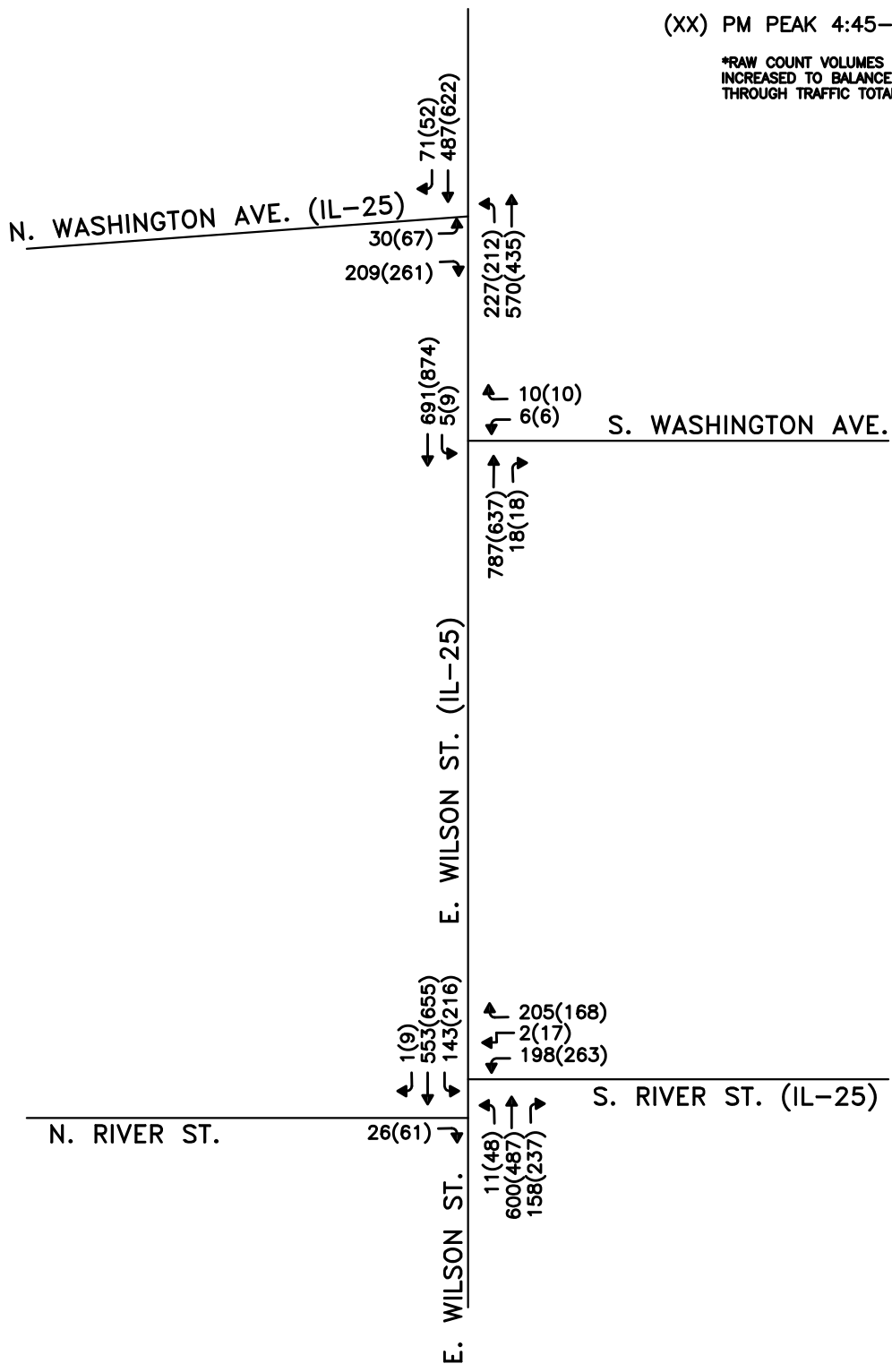

JAMES J. BENES & ASSOCIATES, INC.  
 950 Warrenville Road, Suite 101, Lisle, Illinois 60532  
 Tel. (630) 719-7570 · Fax (630) 719-7589

EXISTING  
 E. WILSON CORRIDOR  
 PEAK HOUR TRAFFIC VOLUMES\*

FIGURE 2

SCALE: Not To Scale

LEGEND

XX AM PEAK HOUR

(XX) PM PEAK HOUR

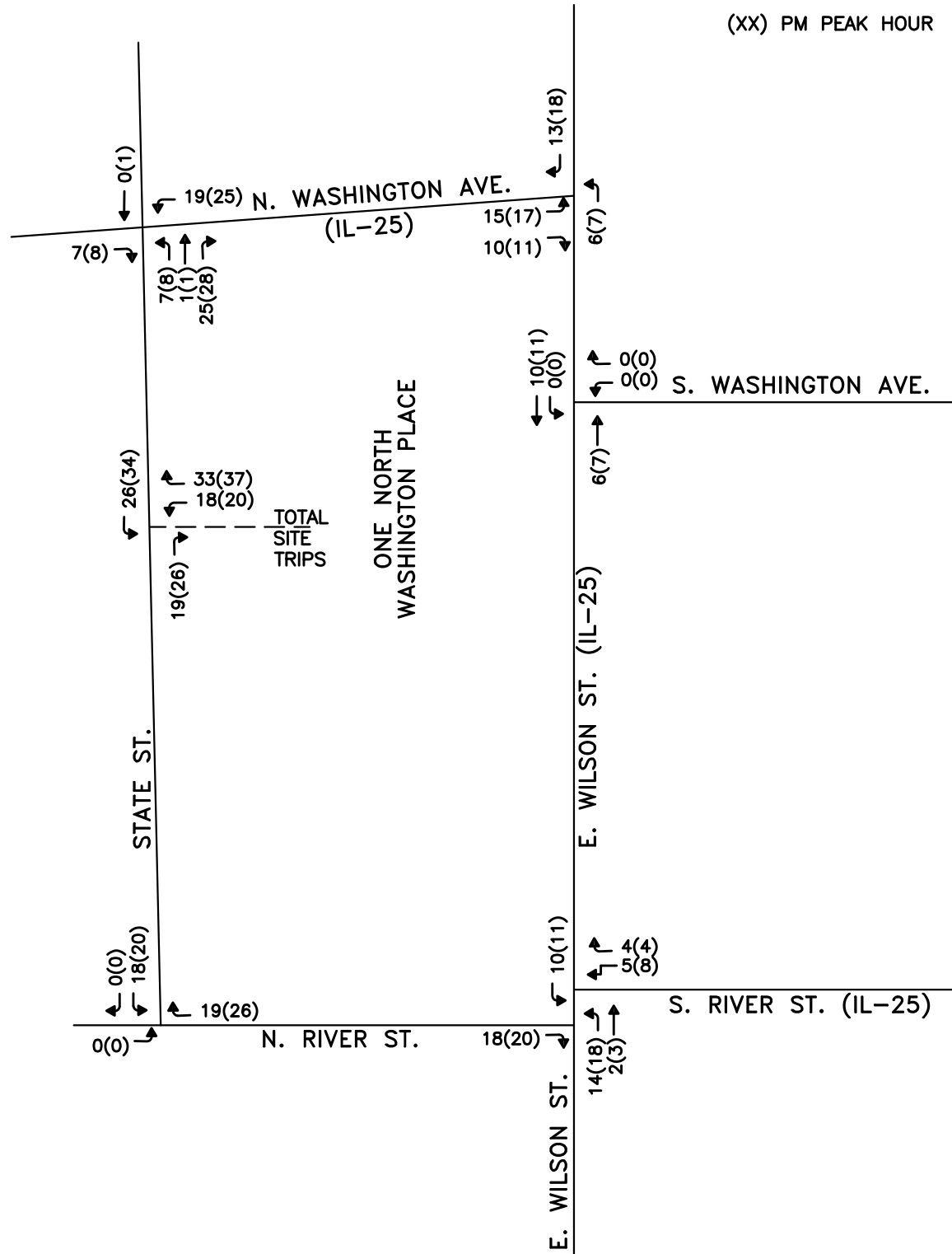

JAMES J. BENES & ASSOCIATES, INC.  
 950 Warrenville Road, Suite 101, Lisle, Illinois 60532  
 Tel. (630) 719-7570 · Fax (630) 719-7589

SITE TRAFFIC

FIGURE 3

SCALE: Not To Scale

**LEGEND**

XX AM PEAK 7:15-8:15 AM  
 (XX) PM PEAK 4:45-5:45 PM

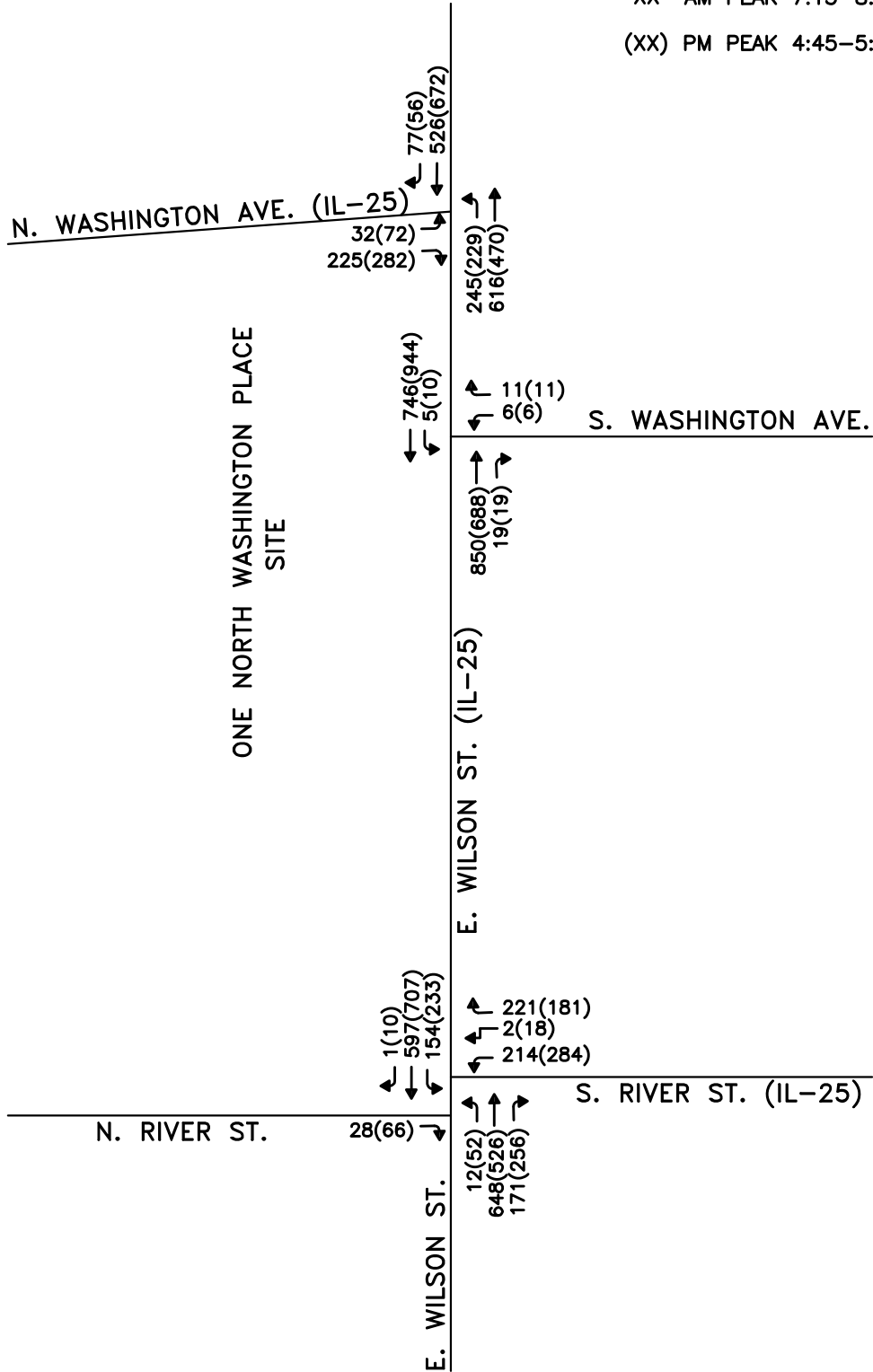

JAMES J. BENES & ASSOCIATES, INC.  
 950 Warrenville Road, Suite 101, Lisle, Illinois 60532  
 Tel. (630) 719-7570 · Fax (630) 719-7589

YEAR 2024  
 NON SITE TRAFFIC

FIGURE 4

SCALE: Not To Scale

**LEGEND**

XX AM PEAK 7:15-8:15 AM  
 (XX) PM PEAK 4:45-5:45 PM

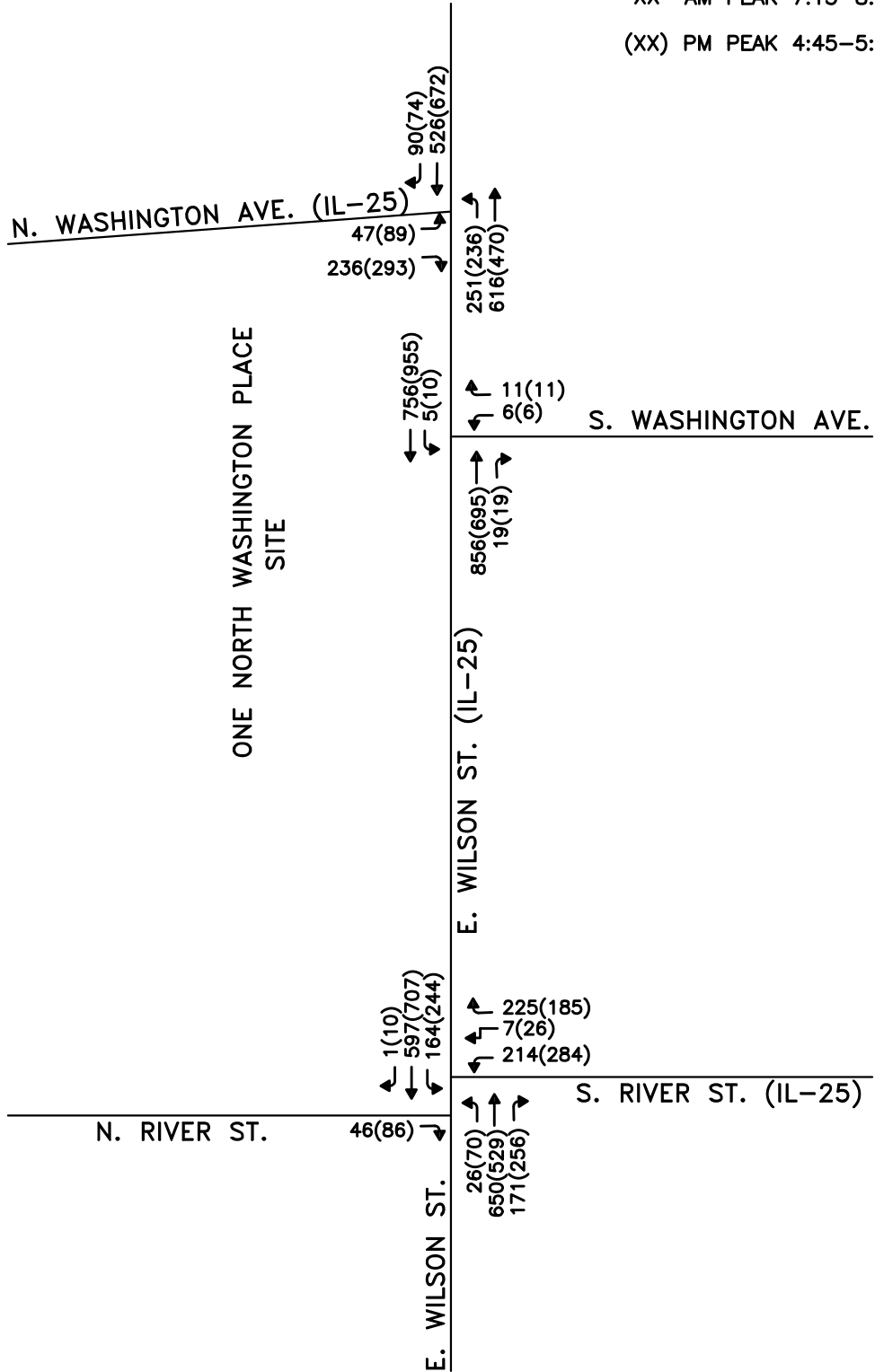

JAMES J. BENES & ASSOCIATES, INC.  
 950 Warrenville Road, Suite 101, Lisle, Illinois 60532  
 Tel. (630) 719-7570 · Fax (630) 719-7589

YEAR 2024  
 TOTAL TRAFFIC

FIGURE 5

# HCS 2010 Two-Way Stop-Control Report

General Information		Site Information	
Analyst	JJB & A	Intersection	N. River/E. Wilson
Agency/Co.	JJB & A	Jurisdiction	Batavia
Date Performed	11/16/2016	East/West Street	E. Wilson
Analysis Year	2016	North/South Street	N. River
Time Analyzed	Existing AM Peak	Peak Hour Factor	0.85
Intersection Orientation	East-West	Analysis Time Period (hrs)	0.25
Project Description	One N Washington Place		

## Lanes

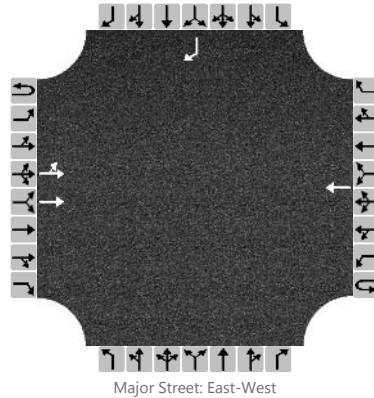

## Vehicle Volumes and Adjustments

Approach	Eastbound				Westbound				Northbound				Southbound			
	U	L	T	R	U	L	T	R	U	L	T	R	U	L	T	R
Movement	1U	1	2	3	4U	4	5	6		7	8	9		10	11	12
Priority																
Number of Lanes	0	0	2	0	0	0	1	0		0	0	0		0	0	1
Configuration		LT	T				T									R
Volume, V (veh/h)		0	769				751									26
Percent Heavy Vehicles (%)		5														4
Proportion Time Blocked																
Percent Grade (%)													0			
Right Turn Channelized	No				No				No				No			
Median Type/Storage	Undivided															

## Critical and Follow-up Headways

Base Critical Headway (sec)		4.1														6.2
Critical Headway (sec)		4.20														6.28
Base Follow-Up Headway (sec)		2.2														3.3
Follow-Up Headway (sec)		2.25														3.34

## Delay, Queue Length, and Level of Service

Flow Rate, v (veh/h)		0														31
Capacity, c (veh/h)		740														336
v/c Ratio		0.00														0.09
95% Queue Length, Q <sub>95</sub> (veh)		0.0														0.3
Control Delay (s/veh)		9.9														16.8
Level of Service, LOS		A														C
Approach Delay (s/veh)	0.0												16.8			
Approach LOS													C			

# HCS 2010 Two-Way Stop-Control Report

General Information		Site Information	
Analyst	JJB & A	Intersection	N. River/E. Wilson
Agency/Co.	JJB & A	Jurisdiction	Batavia
Date Performed	11/16/2016	East/West Street	E. Wilson
Analysis Year	2016	North/South Street	N. River
Time Analyzed	Existing PM Peak	Peak Hour Factor	0.93
Intersection Orientation	East-West	Analysis Time Period (hrs)	0.25
Project Description	One N Washington Place		

## Lanes

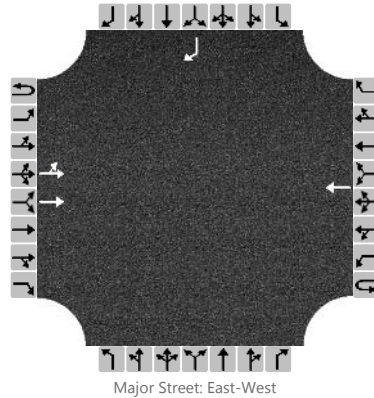

## Vehicle Volumes and Adjustments

Approach	Eastbound				Westbound				Northbound				Southbound			
	U	L	T	R	U	L	T	R	U	L	T	R	U	L	T	R
Movement	1U	1	2	3	4U	4	5	6		7	8	9		10	11	12
Priority																
Number of Lanes	0	0	2	0	0	0	1	0		0	0	0		0	0	1
Configuration		LT	T				T									R
Volume, V (veh/h)		0	772				918									61
Percent Heavy Vehicles (%)		1														0
Proportion Time Blocked																
Percent Grade (%)													0			
Right Turn Channelized	No				No				No				No			
Median Type/Storage	Undivided															

## Critical and Follow-up Headways

Base Critical Headway (sec)		4.1														6.2
Critical Headway (sec)		4.12														6.20
Base Follow-Up Headway (sec)		2.2														3.3
Follow-Up Headway (sec)		2.21														3.30

## Delay, Queue Length, and Level of Service

Flow Rate, v (veh/h)		0														66
Capacity, c (veh/h)		699														301
v/c Ratio		0.00														0.22
95% Queue Length, Q <sub>95</sub> (veh)		0.0														0.8
Control Delay (s/veh)		10.2														20.3
Level of Service, LOS		B														C
Approach Delay (s/veh)	0.0												20.3			
Approach LOS													C			

Lanes, Volumes, Timings  
S. River & E. Wilson

11/16/2016



Lane Group	EBL	EBT	EBR	WBL	WBT	WBR	NBL	NBT	NBR	SBL	SBT	SBR
Lane Configurations												
Traffic Volume (vph)	11	600	158	143	553	1	198	2	205	0	0	0
Future Volume (vph)	11	600	158	143	553	1	198	2	205	0	0	0
Ideal Flow (vphpl)	1900	1900	1900	1900	1900	1900	1900	1900	1900	1900	1900	1900
Lane Width (ft)	11	11	11	11	11	11	12	12	12	12	12	12
Storage Length (ft)	0		0	100		0	0		115	0		0
Storage Lanes	1		0	1		0	0		1	0		0
Taper Length (ft)	0			105			25			25		
Lane Util. Factor	1.00	1.00	1.00	1.00	1.00	1.00	1.00	1.00	1.00	1.00	1.00	1.00
Ped Bike Factor		1.00			1.00							
Frt		0.969							0.850			
Flt Protected	0.950			0.950				0.953				
Satd. Flow (prot)	1678	1703	0	1646	1733	0	0	1678	1495	0	0	0
Flt Permitted	0.418			0.143				0.953				
Satd. Flow (perm)	738	1703	0	248	1733	0	0	1678	1495	0	0	0
Right Turn on Red			Yes			Yes			Yes			No
Satd. Flow (RTOR)		25							225			
Link Speed (mph)		25			25			25				20
Link Distance (ft)		72			213			305				397
Travel Time (s)		2.0			5.8			8.3				13.5
Confl. Peds. (#/hr)			1	1		2						
Peak Hour Factor	0.91	0.91	0.91	0.91	0.91	0.91	0.91	0.91	0.91	0.91	0.91	0.91
Heavy Vehicles (%)	4%	4%	4%	6%	6%	0%	8%	0%	8%	0%	0%	0%
Adj. Flow (vph)	12	659	174	157	608	1	218	2	225	0	0	0
Shared Lane Traffic (%)												
Lane Group Flow (vph)	12	833	0	157	609	0	0	220	225	0	0	0
Turn Type	Perm	NA		pm+pt	NA		Prot	NA	pt+ov			
Protected Phases		2		1	6		3	8	8	1		
Permitted Phases	2			6								
Detector Phase	2	2		1	6		3	8	8	1		
Switch Phase												
Minimum Initial (s)	5.0	5.0		5.0	5.0		5.0	5.0				
Minimum Split (s)	22.5	22.5		9.5	22.5		9.5	22.5				
Total Split (s)	66.0	66.0		10.0	76.0		24.0	24.0				
Total Split (%)	66.0%	66.0%		10.0%	76.0%		24.0%	24.0%				
Maximum Green (s)	61.5	61.5		5.5	71.5		19.5	19.5				
Yellow Time (s)	3.5	3.5		3.5	3.5		3.5	3.5				
All-Red Time (s)	1.0	1.0		1.0	1.0		1.0	1.0				
Lost Time Adjust (s)	0.0	0.0		0.0	0.0			0.0				
Total Lost Time (s)	4.5	4.5		4.5	4.5			4.5				
Lead/Lag	Lag	Lag		Lead								
Lead-Lag Optimize?												
Vehicle Extension (s)	3.0	3.0		3.0	3.0		3.0	3.0				
Recall Mode	C-Min	C-Min		None	C-Min		Min	Min				
Walk Time (s)	7.0	7.0			7.0			7.0				
Flash Dont Walk (s)	11.0	11.0			11.0			11.0				
Pedestrian Calls (#/hr)	0	0			0			0				
Act Effect Green (s)	57.4	57.4		67.4	67.4			23.6	33.6			
Actuated g/C Ratio	0.57	0.57		0.67	0.67			0.24	0.34			



Lanes, Volumes, Timings  
S. River & E. Wilson

11/16/2016



Lane Group	EBL	EBT	EBR	WBL	WBT	WBR	NBL	NBT	NBR	SBL	SBT	SBR
v/c Ratio	0.03	0.84		0.64	0.52			0.56	0.35			
Control Delay	7.9	25.7		23.0	11.6			41.8	5.3			
Queue Delay	0.0	2.2		0.0	0.6			0.0	0.0			
Total Delay	7.9	27.9		23.0	12.2			41.8	5.3			
LOS	A	C		C	B			D	A			
Approach Delay		27.6			14.4			23.3				
Approach LOS		C			B			C				
Queue Length 50th (ft)	3	364		47	254			130	0			
Queue Length 95th (ft)	10	539		69	86			#213	54			
Internal Link Dist (ft)		1			133			225			317	
Turn Bay Length (ft)				100					115			
Base Capacity (vph)	453	1056		244	1239			395	651			
Starvation Cap Reductn	0	114		0	298			0	0			
Spillback Cap Reductn	0	0		0	0			0	0			
Storage Cap Reductn	0	0		0	0			0	0			
Reduced v/c Ratio	0.03	0.88		0.64	0.65			0.56	0.35			

Intersection Summary

Area Type: Other  
 Cycle Length: 100  
 Actuated Cycle Length: 100  
 Offset: 0 (0%), Referenced to phase 2:EBTL and 6:WBTL, Start of Green  
 Natural Cycle: 80  
 Control Type: Actuated-Coordinated  
 Maximum v/c Ratio: 0.84  
 Intersection Signal Delay: 21.8      Intersection LOS: C  
 Intersection Capacity Utilization 71.5%      ICU Level of Service C  
 Analysis Period (min) 15  
 # 95th percentile volume exceeds capacity, queue may be longer.  
 Queue shown is maximum after two cycles.

Splits and Phases: 6: S River/IL-25/N River Departure



Lanes, Volumes, Timings  
S. River & E. Wilson

11/16/2016

Lane Group	EBL	EBT	EBR	WBL	WBT	WBR	NBL	NBT	NBR	SBL	SBT	SBR
Lane Configurations												
Traffic Volume (vph)	48	487	237	216	655	9	263	17	168	0	0	0
Future Volume (vph)	48	487	237	216	655	9	263	17	168	0	0	0
Ideal Flow (vphpl)	1900	1900	1900	1900	1900	1900	1900	1900	1900	1900	1900	1900
Lane Width (ft)	11	11	11	11	11	11	12	12	12	12	12	12
Storage Length (ft)	0		0	100		0	0		115	0		0
Storage Lanes	1		0	1		0	0		1	0		0
Taper Length (ft)	0			105			25			25		
Lane Util. Factor	1.00	1.00	1.00	1.00	1.00	1.00	1.00	1.00	1.00	1.00	1.00	1.00
Ped Bike Factor		0.98			1.00							
Frt		0.951			0.998				0.850			
Flt Protected	0.950			0.950				0.955				
Satd. Flow (prot)	1745	1711	0	1728	1814	0	0	1814	1615	0	0	0
Flt Permitted	0.347			0.120				0.955				
Satd. Flow (perm)	637	1711	0	218	1814	0	0	1814	1615	0	0	0
Right Turn on Red			Yes			Yes			Yes			No
Satd. Flow (RTOR)		26			1				150			
Link Speed (mph)		25			25			25			20	
Link Distance (ft)		72			213			305			397	
Travel Time (s)		2.0			5.8			8.3			13.5	
Confl. Peds. (#/hr)			11	11		3						
Peak Hour Factor	0.98	0.98	0.98	0.98	0.98	0.98	0.98	0.98	0.98	0.98	0.98	0.98
Heavy Vehicles (%)	0%	0%	0%	1%	1%	1%	0%	0%	0%	0%	0%	0%
Adj. Flow (vph)	49	497	242	220	668	9	268	17	171	0	0	0
Shared Lane Traffic (%)												
Lane Group Flow (vph)	49	739	0	220	677	0	0	285	171	0	0	0
Turn Type	Perm	NA		pm+pt	NA		Prot	NA	pt+ov			
Protected Phases		2		1	6		3	8	8	1		
Permitted Phases	2			6								
Detector Phase	2	2		1	6		3	8	8	1		
Switch Phase												
Minimum Initial (s)	5.0	5.0		5.0	5.0		5.0	5.0				
Minimum Split (s)	22.5	22.5		9.5	22.5		9.5	22.5				
Total Split (s)	76.0	76.0		22.0	98.0		42.0	42.0				
Total Split (%)	54.3%	54.3%		15.7%	70.0%		30.0%	30.0%				
Maximum Green (s)	71.5	71.5		17.5	93.5		37.5	37.5				
Yellow Time (s)	3.5	3.5		3.5	3.5		3.5	3.5				
All-Red Time (s)	1.0	1.0		1.0	1.0		1.0	1.0				
Lost Time Adjust (s)	0.0	0.0		0.0	0.0			0.0				
Total Lost Time (s)	4.5	4.5		4.5	4.5			4.5				
Lead/Lag	Lag	Lag		Lead								
Lead-Lag Optimize?												
Vehicle Extension (s)	3.0	3.0		3.0	3.0		3.0	3.0				
Recall Mode	C-Min	C-Min		None	C-Min		Min	Min				
Walk Time (s)	7.0	7.0			7.0			7.0				
Flash Dont Walk (s)	11.0	11.0			11.0			11.0				
Pedestrian Calls (#/hr)	0	0			0			0				
Act Effect Green (s)	68.2	68.2		86.1	86.1			44.9	62.8			
Actuated g/C Ratio	0.49	0.49		0.62	0.62			0.32	0.45			

Lanes, Volumes, Timings  
S. River & E. Wilson

11/16/2016



Lane Group	EBL	EBT	EBR	WBL	WBT	WBR	NBL	NBT	NBR	SBL	SBT	SBR
v/c Ratio	0.16	0.87		0.79	0.61			0.49	0.21			
Control Delay	20.0	42.8		38.2	21.3			43.9	6.0			
Queue Delay	0.0	15.7		0.3	0.8			0.0	0.0			
Total Delay	20.0	58.5		38.6	22.1			43.9	6.0			
LOS	B	E		D	C			D	A			
Approach Delay		56.1			26.1			29.7				
Approach LOS		E			C			C				
Queue Length 50th (ft)	24	557		107	459			213	11			
Queue Length 95th (ft)	49	742		145	341			325	56			
Internal Link Dist (ft)		1			133			225			317	
Turn Bay Length (ft)				100					115			
Base Capacity (vph)	329	895		323	1211			581	849			
Starvation Cap Reductn	0	157		7	253			0	0			
Spillback Cap Reductn	0	0		0	0			0	0			
Storage Cap Reductn	0	0		0	0			0	0			
Reduced v/c Ratio	0.15	1.00		0.70	0.71			0.49	0.20			

Intersection Summary

Area Type: Other  
 Cycle Length: 140  
 Actuated Cycle Length: 140  
 Offset: 0 (0%), Referenced to phase 2:EBTL and 6:WBTL, Start of Green  
 Natural Cycle: 70  
 Control Type: Actuated-Coordinated  
 Maximum v/c Ratio: 0.87  
 Intersection Signal Delay: 37.9  
 Intersection Capacity Utilization 79.1%  
 Analysis Period (min) 15  
 Intersection LOS: D  
 ICU Level of Service D

Splits and Phases: 6: S River/IL-25/N River Departure



# HCS 2010 Two-Way Stop-Control Report

General Information		Site Information	
Analyst	JJB & A	Intersection	S. Washington/E. River
Agency/Co.	JJB & A	Jurisdiction	Batavia
Date Performed	11/16/2016	East/West Street	E. Wilson
Analysis Year	2016	North/South Street	S. Washington
Time Analyzed	Existing AM Pk	Peak Hour Factor	0.83
Intersection Orientation	East-West	Analysis Time Period (hrs)	0.25
Project Description	One N Washington Place		

## Lanes

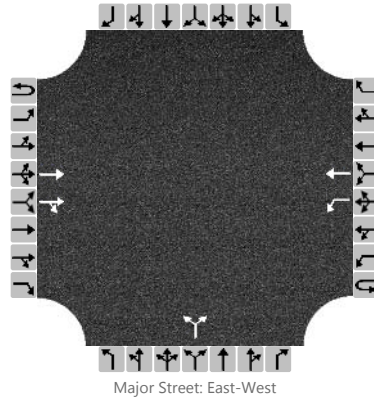

## Vehicle Volumes and Adjustments

Approach	Eastbound				Westbound				Northbound				Southbound			
	U	L	T	R	U	L	T	R	U	L	T	R	U	L	T	R
Movement	1U	1	2	3	4U	4	5	6		7	8	9		10	11	12
Priority																
Number of Lanes	0	0	2	0	0	1	1	0		0	0	0		0	0	0
Configuration			T	TR		L	T				LR					
Volume, V (veh/h)			787	18		5	691			6		10				
Percent Heavy Vehicles (%)						7				0		0				
Proportion Time Blocked																
Percent Grade (%)									0							
Right Turn Channelized	No				No				No				No			
Median Type/Storage	Undivided															

## Critical and Follow-up Headways

Base Critical Headway (sec)						4.1					7.5		6.9			
Critical Headway (sec)						4.24					6.80		6.90			
Base Follow-Up Headway (sec)						2.2					3.5		3.3			
Follow-Up Headway (sec)						2.27					3.50		3.30			

## Delay, Queue Length, and Level of Service

Flow Rate, v (veh/h)						6					19					
Capacity, c (veh/h)						675					158					
v/c Ratio						0.01					0.12					
95% Queue Length, Q <sub>95</sub> (veh)						0.0					0.4					
Control Delay (s/veh)						10.4					30.9					
Level of Service, LOS						B					D					
Approach Delay (s/veh)					0.1				30.9							
Approach LOS									D							

# HCS 2010 Two-Way Stop-Control Report

General Information		Site Information	
Analyst	JJB & A	Intersection	S. Washington/E. River
Agency/Co.	JJB & A	Jurisdiction	Batavia
Date Performed	11/16/2016	East/West Street	E. Wilson
Analysis Year	2016	North/South Street	S. Washington
Time Analyzed	Existing PM Peak	Peak Hour Factor	0.93
Intersection Orientation	East-West	Analysis Time Period (hrs)	0.25
Project Description	One N Washington Place		

## Lanes

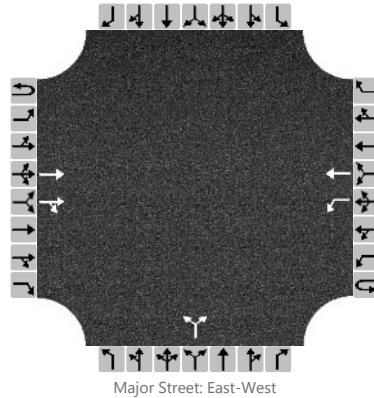

## Vehicle Volumes and Adjustments

Approach	Eastbound				Westbound				Northbound				Southbound			
	U	L	T	R	U	L	T	R	U	L	T	R	U	L	T	R
Movement	1U	1	2	3	4U	4	5	6		7	8	9		10	11	12
Priority																
Number of Lanes	0	0	2	0	0	1	1	0		0	0	0		0	0	0
Configuration			T	TR		L	T				LR					
Volume, V (veh/h)			637	18		9	874			6		10				
Percent Heavy Vehicles (%)						1				0		0				
Proportion Time Blocked																
Percent Grade (%)									0							
Right Turn Channelized	No				No				No				No			
Median Type/Storage	Undivided															

## Critical and Follow-up Headways

Base Critical Headway (sec)						4.1				7.5		6.9				
Critical Headway (sec)						4.12				6.80		6.90				
Base Follow-Up Headway (sec)						2.2				3.5		3.3				
Follow-Up Headway (sec)						2.21				3.50		3.30				

## Delay, Queue Length, and Level of Service

Flow Rate, v (veh/h)						10					17					
Capacity, c (veh/h)						895					202					
v/c Ratio						0.01					0.08					
95% Queue Length, Q <sub>95</sub> (veh)						0.0					0.3					
Control Delay (s/veh)						9.1					24.4					
Level of Service, LOS						A					C					
Approach Delay (s/veh)					0.1				24.4							
Approach LOS									C							

# Lanes, Volumes, Timings

## N. Washington & E. Wilson

11/16/2016



Lane Group	EBL	EBT	WBT	WBR	SBL	SBR
Lane Configurations						
Traffic Volume (vph)	227	570	487	71	30	209
Future Volume (vph)	227	570	487	71	30	209
Ideal Flow (vphpl)	1900	1900	1900	1900	1900	1900
Lane Width (ft)	11	11	11	11	11	11
Storage Length (ft)	0			65	125	125
Storage Lanes	1			1	1	0
Taper Length (ft)	100				140	
Lane Util. Factor	1.00	1.00	1.00	1.00	1.00	1.00
Ped Bike Factor	1.00			0.97	1.00	
Fr <sub>t</sub>				0.850		0.850
Fl <sub>t</sub> Protected	0.950				0.950	
Satd. Flow (prot)	1616	1701	1701	1446	1662	1487
Fl <sub>t</sub> Permitted	0.354				0.950	
Satd. Flow (perm)	601	1701	1701	1405	1657	1487
Right Turn on Red				Yes		Yes
Satd. Flow (RTOR)				64		249
Link Speed (mph)		25	25		30	
Link Distance (ft)		112	341		418	
Travel Time (s)		3.1	9.3		9.5	
Confl. Peds. (#/hr)	3			3	1	
Peak Hour Factor	0.84	0.84	0.84	0.84	0.84	0.84
Heavy Vehicles (%)	8%	8%	8%	8%	5%	5%
Adj. Flow (vph)	270	679	580	85	36	249
Shared Lane Traffic (%)						
Lane Group Flow (vph)	270	679	580	85	36	249
Turn Type	pm+pt	NA	NA	Perm	Perm	Perm
Protected Phases	5	2	6			
Permitted Phases	2			6	4	4
Detector Phase	5	2	6	6	4	4
Switch Phase						
Minimum Initial (s)	1.5	5.0	5.0	5.0	5.0	5.0
Minimum Split (s)	6.0	22.5	22.5	22.5	14.0	14.0
Total Split (s)	6.0	81.0	75.0	75.0	19.0	19.0
Total Split (%)	6.0%	81.0%	75.0%	75.0%	19.0%	19.0%
Maximum Green (s)	1.5	76.5	70.5	70.5	14.5	14.5
Yellow Time (s)	3.5	3.5	3.5	3.5	3.5	3.5
All-Red Time (s)	1.0	1.0	1.0	1.0	1.0	1.0
Lost Time Adjust (s)	0.0	0.0	0.0	0.0	0.0	0.0
Total Lost Time (s)	4.5	4.5	4.5	4.5	4.5	4.5
Lead/Lag	Lead		Lag	Lag		
Lead-Lag Optimize?	Yes		Yes	Yes		
Vehicle Extension (s)	3.0	3.0	3.0	3.0	3.0	3.0
Recall Mode	None	C-Min	C-Min	C-Min	None	None
Walk Time (s)		7.0	7.0	7.0	7.0	7.0
Flash Dont Walk (s)		11.0	11.0	11.0	11.0	11.0
Pedestrian Calls (#/hr)		0	0	0	0	0
Act Effct Green (s)	82.2	82.2	68.4	68.4	8.8	8.8
Actuated g/C Ratio	0.82	0.82	0.68	0.68	0.09	0.09

Lanes, Volumes, Timings  
N. Washington & E. Wilson

11/16/2016

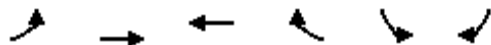

Lane Group	EBL	EBT	WBT	WBR	SBL	SBR
v/c Ratio	0.46	0.49	0.50	0.09	0.25	0.70
Control Delay	5.8	6.8	10.6	3.1	45.0	16.4
Queue Delay	0.8	1.1	0.0	0.0	0.0	0.0
Total Delay	6.7	7.9	10.6	3.1	45.0	16.4
LOS	A	A	B	A	D	B
Approach Delay		7.5	9.6		20.0	
Approach LOS		A	A		B	
Queue Length 50th (ft)	47	187	146	4	22	0
Queue Length 95th (ft)	m70	208	285	22	46	53
Internal Link Dist (ft)		32	261		338	
Turn Bay Length (ft)				65	125	125
Base Capacity (vph)	589	1400	1217	1023	241	429
Starvation Cap Reductn	125	452	0	0	0	0
Spillback Cap Reductn	0	0	0	0	0	0
Storage Cap Reductn	0	0	0	0	0	0
Reduced v/c Ratio	0.58	0.72	0.48	0.08	0.15	0.58

Intersection Summary

Area Type: Other  
 Cycle Length: 100  
 Actuated Cycle Length: 100  
 Offset: 0 (0%), Referenced to phase 2:EBTL and 6:WBT, Start of Green  
 Natural Cycle: 60  
 Control Type: Actuated-Coordinated  
 Maximum v/c Ratio: 0.70  
 Intersection Signal Delay: 10.1  
 Intersection LOS: B  
 Intersection Capacity Utilization 53.6%  
 ICU Level of Service A  
 Analysis Period (min) 15  
 m Volume for 95th percentile queue is metered by upstream signal.

Splits and Phases: 10: E Wilson & N Washington (IL25)

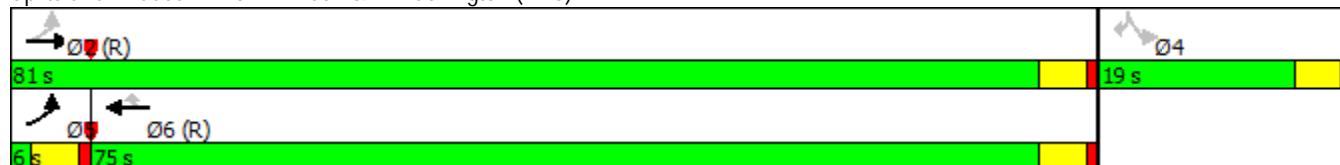

Lanes, Volumes, Timings  
N. Washington & E. Wilson

11/16/2016



Lane Group	EBL	EBT	WBT	WBR	SBL	SBR
Lane Configurations						
Traffic Volume (vph)	212	435	622	52	67	261
Future Volume (vph)	212	435	622	52	67	261
Ideal Flow (vphpl)	1900	1900	1900	1900	1900	1900
Lane Width (ft)	11	11	11	11	11	11
Storage Length (ft)	0			65	125	125
Storage Lanes	1			1	1	0
Taper Length (ft)	100				140	
Lane Util. Factor	1.00	1.00	1.00	1.00	1.00	1.00
Ped Bike Factor				0.96	1.00	0.97
Frt				0.850		0.850
Flt Protected	0.950				0.950	
Satd. Flow (prot)	1728	1818	1818	1546	1728	1546
Flt Permitted	0.324				0.950	
Satd. Flow (perm)	589	1818	1818	1485	1721	1503
Right Turn on Red				Yes		Yes
Satd. Flow (RTOR)				18		290
Link Speed (mph)		25	25		30	
Link Distance (ft)		112	341		418	
Travel Time (s)		3.1	9.3		9.5	
Confl. Peds. (#/hr)	5			5	1	2
Peak Hour Factor	0.90	0.90	0.90	0.90	0.90	0.90
Heavy Vehicles (%)	1%	1%	1%	1%	1%	1%
Adj. Flow (vph)	236	483	691	58	74	290
Shared Lane Traffic (%)						
Lane Group Flow (vph)	236	483	691	58	74	290
Turn Type	pm+pt	NA	NA	Perm	Perm	Perm
Protected Phases	5	2	6			
Permitted Phases	2			6	4	4
Detector Phase	5	2	6	6	4	4
Switch Phase						
Minimum Initial (s)	1.5	5.0	5.0	5.0	5.0	5.0
Minimum Split (s)	6.0	22.5	22.5	22.5	14.0	14.0
Total Split (s)	18.0	103.0	85.0	85.0	37.0	37.0
Total Split (%)	12.9%	73.6%	60.7%	60.7%	26.4%	26.4%
Maximum Green (s)	13.5	98.5	80.5	80.5	32.5	32.5
Yellow Time (s)	3.5	3.5	3.5	3.5	3.5	3.5
All-Red Time (s)	1.0	1.0	1.0	1.0	1.0	1.0
Lost Time Adjust (s)	0.0	0.0	0.0	0.0	0.0	0.0
Total Lost Time (s)	4.5	4.5	4.5	4.5	4.5	4.5
Lead/Lag	Lead		Lag	Lag		
Lead-Lag Optimize?	Yes		Yes	Yes		
Vehicle Extension (s)	3.0	3.0	3.0	3.0	3.0	3.0
Recall Mode	None	C-Min	C-Min	C-Min	None	None
Walk Time (s)		7.0	7.0	7.0	7.0	7.0
Flash Dont Walk (s)		11.0	11.0	11.0	11.0	11.0
Pedestrian Calls (#/hr)		0	0	0	0	0
Act Effect Green (s)	119.2	119.2	105.7	105.7	11.8	11.8
Actuated g/C Ratio	0.85	0.85	0.76	0.76	0.08	0.08



Lanes, Volumes, Timings  
 N. Washington & E. Wilson

11/16/2016



Lane Group	EBL	EBT	WBT	WBR	SBL	SBR
v/c Ratio	0.41	0.31	0.50	0.05	0.51	0.74
Control Delay	5.6	5.3	9.1	4.2	72.5	18.2
Queue Delay	0.9	1.2	0.4	0.0	0.0	0.3
Total Delay	6.6	6.5	9.5	4.2	72.5	18.5
LOS	A	A	A	A	E	B
Approach Delay		6.5	9.1		29.5	
Approach LOS		A	A		C	
Queue Length 50th (ft)	59	155	214	8	66	0
Queue Length 95th (ft)	m76	m174	389	26	114	91
Internal Link Dist (ft)		32	261		338	
Turn Bay Length (ft)				65	125	125
Base Capacity (vph)	611	1547	1372	1125	399	571
Starvation Cap Reductn	178	801	0	0	0	0
Spillback Cap Reductn	0	0	272	0	0	43
Storage Cap Reductn	0	0	0	0	0	0
Reduced v/c Ratio	0.55	0.65	0.63	0.05	0.19	0.55

Intersection Summary

Area Type: Other  
 Cycle Length: 140  
 Actuated Cycle Length: 140  
 Offset: 0 (0%), Referenced to phase 2:EBTL and 6:WBT, Start of Green  
 Natural Cycle: 60  
 Control Type: Actuated-Coordinated  
 Maximum v/c Ratio: 0.74  
 Intersection Signal Delay: 12.1 Intersection LOS: B  
 Intersection Capacity Utilization 60.6% ICU Level of Service B  
 Analysis Period (min) 15  
 m Volume for 95th percentile queue is metered by upstream signal.

Splits and Phases: 10: E Wilson & N Washington (IL25)

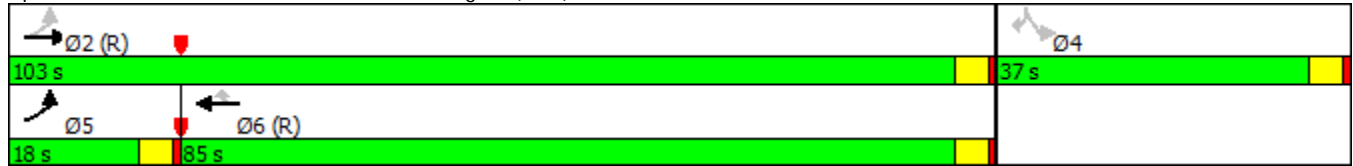

# HCS 2010 Two-Way Stop-Control Report

General Information		Site Information	
Analyst	JJB & A	Intersection	N. River/E. Wilson
Agency/Co.	JJB & A	Jurisdiction	Batavia
Date Performed	11/16/2016	East/West Street	E. Wilson
Analysis Year	2016	North/South Street	N. River
Time Analyzed	2024 Total Traffic AM Pk	Peak Hour Factor	0.95
Intersection Orientation	East-West	Analysis Time Period (hrs)	0.25
Project Description	One N Washington Place		

## Lanes

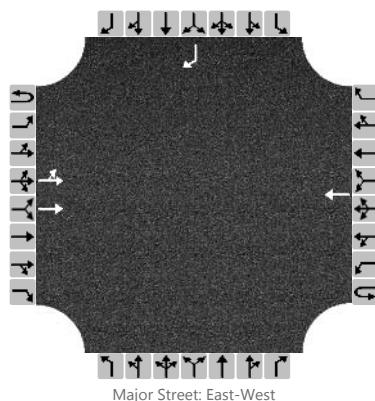

## Vehicle Volumes and Adjustments

Approach	Eastbound				Westbound				Northbound				Southbound			
	U	L	T	R	U	L	T	R	U	L	T	R	U	L	T	R
Movement	1U	1	2	3	4U	4	5	6		7	8	9		10	11	12
Priority																
Number of Lanes	0	0	2	0	0	0	1	0		0	0	0		0	0	1
Configuration		LT	T				T									R
Volume, V (veh/h)		0	847				811									46
Percent Heavy Vehicles (%)		5														4
Proportion Time Blocked																
Percent Grade (%)													0			
Right Turn Channelized	No				No				No				No			
Median Type/Storage	Undivided															

## Critical and Follow-up Headways

Base Critical Headway (sec)		4.1														6.2
Critical Headway (sec)		4.20														6.28
Base Follow-Up Headway (sec)		2.2														3.3
Follow-Up Headway (sec)		2.25														3.34

## Delay, Queue Length, and Level of Service

Flow Rate, v (veh/h)		0														48
Capacity, c (veh/h)		760														350
v/c Ratio		0.00														0.14
95% Queue Length, Q <sub>95</sub> (veh)		0.0														0.5
Control Delay (s/veh)		9.7														16.9
Level of Service, LOS		A														C
Approach Delay (s/veh)	0.0												16.9			
Approach LOS													C			

# HCS 2010 Two-Way Stop-Control Report

General Information		Site Information	
Analyst	JJB & A	Intersection	N. River/E. Wilson
Agency/Co.	JJB & A	Jurisdiction	Batavia
Date Performed	11/16/2016	East/West Street	E. Wilson
Analysis Year	2016	North/South Street	N. River
Time Analyzed	2024 TT PM Pk	Peak Hour Factor	0.95
Intersection Orientation	East-West	Analysis Time Period (hrs)	0.25
Project Description	One N Washington Place		

## Lanes

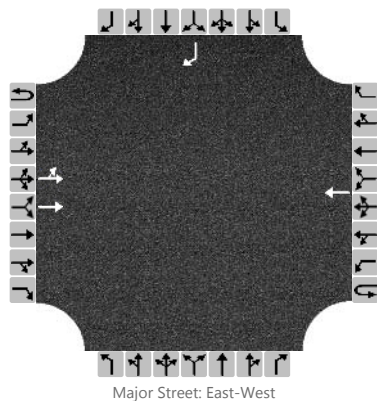

## Vehicle Volumes and Adjustments

Approach	Eastbound				Westbound				Northbound				Southbound			
	U	L	T	R	U	L	T	R	U	L	T	R	U	L	T	R
Movement	1U	1	2	3	4U	4	5	6		7	8	9		10	11	12
Priority																
Number of Lanes	0	0	2	0	0	0	1	0		0	0	0		0	0	1
Configuration		LT	T				T									R
Volume, V (veh/h)		0	855				991									86
Percent Heavy Vehicles (%)		1														0
Proportion Time Blocked																
Percent Grade (%)													0			
Right Turn Channelized	No				No				No				No			
Median Type/Storage	Undivided															

## Critical and Follow-up Headways

Base Critical Headway (sec)		4.1														6.2
Critical Headway (sec)		4.12														6.20
Base Follow-Up Headway (sec)		2.2														3.3
Follow-Up Headway (sec)		2.21														3.30

## Delay, Queue Length, and Level of Service

Flow Rate, v (veh/h)		0														91
Capacity, c (veh/h)		666														280
v/c Ratio		0.00														0.33
95% Queue Length, Q <sub>95</sub> (veh)		0.0														1.4
Control Delay (s/veh)		10.4														24.0
Level of Service, LOS		B														C
Approach Delay (s/veh)	0.0												24.0			
Approach LOS													C			

Lanes, Volumes, Timings  
S. River & E. Wilson

11/16/2016



Lane Group	EBL	EBT	EBR	WBL	WBT	WBR	NBL	NBT	NBR	SBL	SBT	SBR
Lane Configurations												
Traffic Volume (vph)	26	650	171	164	597	1	214	7	225	0	0	0
Future Volume (vph)	26	650	171	164	597	1	214	7	225	0	0	0
Ideal Flow (vphpl)	1900	1900	1900	1900	1900	1900	1900	1900	1900	1900	1900	1900
Lane Width (ft)	11	11	11	11	11	11	12	12	12	12	12	12
Storage Length (ft)	0		0	100		0	0		115	0		0
Storage Lanes	1		0	1		0	0		1	0		0
Taper Length (ft)	0			105			25			25		
Lane Util. Factor	1.00	1.00	1.00	1.00	1.00	1.00	1.00	1.00	1.00	1.00	1.00	1.00
Ped Bike Factor		1.00			1.00							
Frt		0.969							0.850			
Flt Protected	0.950			0.950				0.954				
Satd. Flow (prot)	1678	1703	0	1646	1733	0	0	1682	1495	0	0	0
Flt Permitted	0.408			0.133				0.954				
Satd. Flow (perm)	721	1703	0	230	1733	0	0	1682	1495	0	0	0
Right Turn on Red			Yes			Yes			Yes			No
Satd. Flow (RTOR)		25							237			
Link Speed (mph)		25			25			25				20
Link Distance (ft)		72			213			305				397
Travel Time (s)		2.0			5.8			8.3				13.5
Confl. Peds. (#/hr)			1	1		2						
Peak Hour Factor	0.95	0.95	0.95	0.95	0.95	0.95	0.95	0.95	0.95	0.95	0.95	0.95
Heavy Vehicles (%)	4%	4%	4%	6%	6%	0%	8%	0%	8%	0%	0%	0%
Adj. Flow (vph)	27	684	180	173	628	1	225	7	237	0	0	0
Shared Lane Traffic (%)												
Lane Group Flow (vph)	27	864	0	173	629	0	0	232	237	0	0	0
Turn Type	Perm	NA		pm+pt	NA		Prot	NA	pt+ov			
Protected Phases		2		1	6		3	8	8	1		
Permitted Phases	2			6								
Detector Phase	2	2		1	6		3	8	8	1		
Switch Phase												
Minimum Initial (s)	5.0	5.0		5.0	5.0		5.0	5.0				
Minimum Split (s)	22.5	22.5		9.5	22.5		9.5	22.5				
Total Split (s)	66.0	66.0		10.0	76.0		24.0	24.0				
Total Split (%)	66.0%	66.0%		10.0%	76.0%		24.0%	24.0%				
Maximum Green (s)	61.5	61.5		5.5	71.5		19.5	19.5				
Yellow Time (s)	3.5	3.5		3.5	3.5		3.5	3.5				
All-Red Time (s)	1.0	1.0		1.0	1.0		1.0	1.0				
Lost Time Adjust (s)	0.0	0.0		0.0	0.0			0.0				
Total Lost Time (s)	4.5	4.5		4.5	4.5			4.5				
Lead/Lag	Lag	Lag		Lead								
Lead-Lag Optimize?												
Vehicle Extension (s)	3.0	3.0		3.0	3.0		3.0	3.0				
Recall Mode	C-Min	C-Min		None	C-Min		Min	Min				
Walk Time (s)	7.0	7.0			7.0			7.0				
Flash Dont Walk (s)	11.0	11.0			11.0			11.0				
Pedestrian Calls (#/hr)	0	0			0			0				
Act Effct Green (s)	58.4	58.4		68.4	68.4			22.6	32.6			
Actuated g/C Ratio	0.58	0.58		0.68	0.68			0.23	0.33			

Lanes, Volumes, Timings  
S. River & E. Wilson

11/16/2016



Lane Group	EBL	EBT	EBR	WBL	WBT	WBR	NBL	NBT	NBR	SBL	SBT	SBR
v/c Ratio	0.06	0.86		0.74	0.53			0.61	0.37			
Control Delay	8.3	26.7		30.8	12.2			44.3	5.4			
Queue Delay	0.0	3.3		0.0	0.7			0.0	0.0			
Total Delay	8.3	30.0		30.8	12.9			44.3	5.4			
LOS	A	C		C	B			D	A			
Approach Delay		29.4			16.8			24.6				
Approach LOS		C			B			C				
Queue Length 50th (ft)	6	382		53	273			139	0			
Queue Length 95th (ft)	18	585		#109	91			#240	55			
Internal Link Dist (ft)		1			133			225			317	
Turn Bay Length (ft)				100					115			
Base Capacity (vph)	443	1056		235	1239			380	647			
Starvation Cap Reductn	0	114		0	302			0	0			
Spillback Cap Reductn	0	0		0	0			0	0			
Storage Cap Reductn	0	0		0	0			0	0			
Reduced v/c Ratio	0.06	0.92		0.74	0.67			0.61	0.37			

Intersection Summary



















Area Type: Other  
 Cycle Length: 100  
 Actuated Cycle Length: 100  
 Offset: 0 (0%), Referenced to phase 2:EBTL and 6:WBTL, Start of Green  
 Natural Cycle: 90  
 Control Type: Actuated-Coordinated  
 Maximum v/c Ratio: 0.86  
 Intersection Signal Delay: 23.7  
 Intersection LOS: C  
 Intersection Capacity Utilization 77.2%  
 ICU Level of Service D  
 Analysis Period (min) 15  
 # 95th percentile volume exceeds capacity, queue may be longer.  
 Queue shown is maximum after two cycles.

Splits and Phases: 6: S River/IL-25/N River Departure



Lanes, Volumes, Timings  
S. River & E. Wilson

11/16/2016

													
Lane Group	EBL	EBT	EBR	WBL	WBT	WBR	NBL	NBT	NBR	SBL	SBT	SBR	
Lane Configurations													
Traffic Volume (vph)	70	529	256	244	707	10	284	26	185	0	0	0	
Future Volume (vph)	70	529	256	244	707	10	284	26	185	0	0	0	
Ideal Flow (vphpl)	1900	1900	1900	1900	1900	1900	1900	1900	1900	1900	1900	1900	
Lane Width (ft)	11	11	11	11	11	11	12	12	12	12	12	12	
Storage Length (ft)	0		0	100		0	0		115	0		0	
Storage Lanes	1		0	1		0	0		1	0		0	
Taper Length (ft)	0			105			25			25			
Lane Util. Factor	1.00	1.00	1.00	1.00	1.00	1.00	1.00	1.00	1.00	1.00	1.00	1.00	
Ped Bike Factor		0.98			1.00								
Frt		0.951			0.998				0.850				
Flt Protected	0.950			0.950				0.956					
Satd. Flow (prot)	1745	1711	0	1728	1814	0	0	1816	1615	0	0	0	
Flt Permitted	0.334			0.087				0.956					
Satd. Flow (perm)	613	1711	0	158	1814	0	0	1816	1615	0	0	0	
Right Turn on Red			Yes			Yes			Yes			No	
Satd. Flow (RTOR)		25			1				149				
Link Speed (mph)		25			25			25			20		
Link Distance (ft)		72			213			305			397		
Travel Time (s)		2.0			5.8			8.3			13.5		
Confl. Peds. (#/hr)			11	11		3							
Peak Hour Factor	0.98	0.98	0.98	0.98	0.98	0.98	0.98	0.98	0.98	0.98	0.98	0.98	
Heavy Vehicles (%)	0%	0%	0%	1%	1%	1%	0%	0%	0%	0%	0%	0%	
Adj. Flow (vph)	71	540	261	249	721	10	290	27	189	0	0	0	
Shared Lane Traffic (%)													
Lane Group Flow (vph)	71	801	0	249	731	0	0	317	189	0	0	0	
Turn Type	Perm	NA		pm+pt	NA		Prot	NA	pt+ov				
Protected Phases		2		1	6		3	8	8	1			
Permitted Phases	2			6									
Detector Phase	2	2		1	6		3	8	8	1			
Switch Phase													
Minimum Initial (s)	5.0	5.0		5.0	5.0		5.0	5.0					
Minimum Split (s)	22.5	22.5		9.5	22.5		9.5	22.5					
Total Split (s)	76.0	76.0		22.0	98.0		42.0	42.0					
Total Split (%)	54.3%	54.3%		15.7%	70.0%		30.0%	30.0%					
Maximum Green (s)	71.5	71.5		17.5	93.5		37.5	37.5					
Yellow Time (s)	3.5	3.5		3.5	3.5		3.5	3.5					
All-Red Time (s)	1.0	1.0		1.0	1.0		1.0	1.0					
Lost Time Adjust (s)	0.0	0.0		0.0	0.0			0.0					
Total Lost Time (s)	4.5	4.5		4.5	4.5			4.5					
Lead/Lag	Lag	Lag		Lead									
Lead-Lag Optimize?													
Vehicle Extension (s)	3.0	3.0		3.0	3.0		3.0	3.0					
Recall Mode	C-Min	C-Min		None	C-Min		Min	Min					
Walk Time (s)	7.0	7.0			7.0			7.0					
Flash Dont Walk (s)	11.0	11.0			11.0			11.0					
Pedestrian Calls (#/hr)	0	0			0			0					
Act Effect Green (s)	69.7	69.7		89.9	89.9			41.1	61.3				
Actuated g/C Ratio	0.50	0.50		0.64	0.64			0.29	0.44				

Lanes, Volumes, Timings  
S. River & E. Wilson

11/16/2016



Lane Group	EBL	EBT	EBR	WBL	WBT	WBR	NBL	NBT	NBR	SBL	SBT	SBR
v/c Ratio	0.23	0.93		0.90	0.63			0.60	0.24			
Control Delay	21.8	49.3		59.9	20.1			49.1	7.2			
Queue Delay	0.0	44.0		0.7	1.0			0.0	0.0			
Total Delay	21.8	93.3		60.6	21.1			49.1	7.2			
LOS	C	F		E	C			D	A			
Approach Delay		87.5			31.2			33.5				
Approach LOS		F			C			C				
Queue Length 50th (ft)	35	631		138	488			257	21			
Queue Length 95th (ft)	70	#915		#272	269			365	71			
Internal Link Dist (ft)		1			133			225			317	
Turn Bay Length (ft)				100					115			
Base Capacity (vph)	313	886		297	1211			532	809			
Starvation Cap Reductn	0	153		4	245			0	0			
Spillback Cap Reductn	0	0		0	0			0	0			
Storage Cap Reductn	0	0		0	0			0	0			
Reduced v/c Ratio	0.23	1.09		0.85	0.76			0.60	0.23			

Intersection Summary

Area Type: Other  
 Cycle Length: 140  
 Actuated Cycle Length: 140  
 Offset: 0 (0%), Referenced to phase 2:EBTL and 6:WBTL, Start of Green  
 Natural Cycle: 75  
 Control Type: Actuated-Coordinated  
 Maximum v/c Ratio: 0.93  
 Intersection Signal Delay: 52.5 Intersection LOS: D  
 Intersection Capacity Utilization 85.7% ICU Level of Service E  
 Analysis Period (min) 15  
 # 95th percentile volume exceeds capacity, queue may be longer.  
 Queue shown is maximum after two cycles.

Splits and Phases: 6: S River/IL-25/N River Departure



Lanes, Volumes, Timings  
S. River & E. Wilson

11/17/2016



Lane Group	EBL	EBT	EBR	WBL	WBT	WBR	NBL	NBT	NBR	SBL	SBT	SBR
Lane Configurations												
Traffic Volume (vph)	52	526	256	233	707	10	284	18	181	0	0	0
Future Volume (vph)	52	526	256	233	707	10	284	18	181	0	0	0
Ideal Flow (vphpl)	1900	1900	1900	1900	1900	1900	1900	1900	1900	1900	1900	1900
Lane Width (ft)	11	11	11	11	11	11	12	12	12	12	12	12
Storage Length (ft)	0		0	100		0	0		115	0		0
Storage Lanes	1		0	1		0	0		1	0		0
Taper Length (ft)	0			105			25			25		
Lane Util. Factor	1.00	1.00	1.00	1.00	1.00	1.00	1.00	1.00	1.00	1.00	1.00	1.00
Ped Bike Factor		0.98			1.00							
Frt		0.951			0.998				0.850			
Flt Protected	0.950			0.950				0.955				
Satd. Flow (prot)	1745	1711	0	1728	1814	0	0	1814	1615	0	0	0
Flt Permitted	0.330			0.092				0.955				
Satd. Flow (perm)	606	1711	0	167	1814	0	0	1814	1615	0	0	0
Right Turn on Red			Yes			Yes			Yes			No
Satd. Flow (RTOR)		26			1				150			
Link Speed (mph)		25			25			25				20
Link Distance (ft)		72			213			305				397
Travel Time (s)		2.0			5.8			8.3				13.5
Confl. Peds. (#/hr)			11	11		3						
Peak Hour Factor	0.98	0.98	0.98	0.98	0.98	0.98	0.98	0.98	0.98	0.98	0.98	0.98
Heavy Vehicles (%)	0%	0%	0%	1%	1%	1%	0%	0%	0%	0%	0%	0%
Adj. Flow (vph)	53	537	261	238	721	10	290	18	185	0	0	0
Shared Lane Traffic (%)												
Lane Group Flow (vph)	53	798	0	238	731	0	0	308	185	0	0	0
Turn Type	Perm	NA		pm+pt	NA		Prot	NA	pt+ov			
Protected Phases		2		1	6		3	8	8	1		
Permitted Phases	2			6								
Detector Phase	2	2		1	6		3	8	8	1		
Switch Phase												
Minimum Initial (s)	5.0	5.0		5.0	5.0		5.0	5.0				
Minimum Split (s)	22.5	22.5		9.5	22.5		9.5	22.5				
Total Split (s)	76.0	76.0		22.0	98.0		42.0	42.0				
Total Split (%)	54.3%	54.3%		15.7%	70.0%		30.0%	30.0%				
Maximum Green (s)	71.5	71.5		17.5	93.5		37.5	37.5				
Yellow Time (s)	3.5	3.5		3.5	3.5		3.5	3.5				
All-Red Time (s)	1.0	1.0		1.0	1.0		1.0	1.0				
Lost Time Adjust (s)	0.0	0.0		0.0	0.0			0.0				
Total Lost Time (s)	4.5	4.5		4.5	4.5			4.5				
Lead/Lag	Lag	Lag		Lead								
Lead-Lag Optimize?												
Vehicle Extension (s)	3.0	3.0		3.0	3.0		3.0	3.0				
Recall Mode	C-Min	C-Min		None	C-Min		Min	Min				
Walk Time (s)	7.0	7.0			7.0			7.0				
Flash Dont Walk (s)	11.0	11.0			11.0			11.0				
Pedestrian Calls (#/hr)	0	0			0			0				
Act Effect Green (s)	70.0	70.0		89.6	89.6			41.4	61.0			
Actuated g/C Ratio	0.50	0.50		0.64	0.64			0.30	0.44			



Lanes, Volumes, Timings  
S. River & E. Wilson

11/17/2016



Lane Group	EBL	EBT	EBR	WBL	WBT	WBR	NBL	NBT	NBR	SBL	SBT	SBR
v/c Ratio	0.18	0.92		0.87	0.63			0.57	0.23			
Control Delay	20.4	48.0		53.6	21.3			48.2	6.9			
Queue Delay	0.0	44.5		0.7	1.2			0.0	0.0			
Total Delay	20.4	92.5		54.3	22.4			48.2	6.9			
LOS	C	F		D	C			D	A			
Approach Delay		88.0			30.3			32.7				
Approach LOS		F			C			C				
Queue Length 50th (ft)	25	612		123	501			249	19			
Queue Length 95th (ft)	54	#910		#241	343			354	66			
Internal Link Dist (ft)		1			133			225			317	
Turn Bay Length (ft)				100					115			
Base Capacity (vph)	310	889		301	1211			536	813			
Starvation Cap Reductn	0	159		6	260			0	0			
Spillback Cap Reductn	0	0		0	0			0	0			
Storage Cap Reductn	0	0		0	0			0	0			
Reduced v/c Ratio	0.17	1.09		0.81	0.77			0.57	0.23			

Intersection Summary

Area Type: Other  
 Cycle Length: 140  
 Actuated Cycle Length: 140  
 Offset: 0 (0%), Referenced to phase 2:EBTL and 6:WBTL, Start of Green  
 Natural Cycle: 75  
 Control Type: Actuated-Coordinated  
 Maximum v/c Ratio: 0.92  
 Intersection Signal Delay: 52.0 Intersection LOS: D  
 Intersection Capacity Utilization 84.5% ICU Level of Service E  
 Analysis Period (min) 15  
 # 95th percentile volume exceeds capacity, queue may be longer.  
 Queue shown is maximum after two cycles.

Splits and Phases: 6: S River/IL-25/N River Departure



# HCS 2010 Two-Way Stop-Control Report

General Information		Site Information	
Analyst	JJB & A	Intersection	S. Washington/E. River
Agency/Co.	JJB & A	Jurisdiction	Batavia
Date Performed	11/16/2016	East/West Street	E. Wilson
Analysis Year	2016	North/South Street	S. Washington
Time Analyzed	2024 Total Traffic AM Pk	Peak Hour Factor	0.95
Intersection Orientation	East-West	Analysis Time Period (hrs)	0.25
Project Description	One N Washington Place		

## Lanes

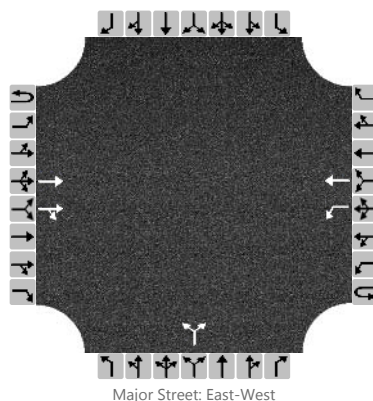

## Vehicle Volumes and Adjustments

Approach	Eastbound				Westbound				Northbound				Southbound			
	U	L	T	R	U	L	T	R	U	L	T	R	U	L	T	R
Movement	1U	1	2	3	4U	4	5	6		7	8	9		10	11	12
Priority																
Number of Lanes	0	0	2	0	0	1	1	0		0	0	0		0	0	0
Configuration			T	TR		L	T				LR					
Volume, V (veh/h)			856	19		5	756			6		11				
Percent Heavy Vehicles (%)						7				0		0				
Proportion Time Blocked																
Percent Grade (%)									0							
Right Turn Channelized	No				No				No				No			
Median Type/Storage	Undivided															

## Critical and Follow-up Headways

Base Critical Headway (sec)						4.1					7.5		6.9			
Critical Headway (sec)						4.24					6.80		6.90			
Base Follow-Up Headway (sec)						2.2					3.5		3.3			
Follow-Up Headway (sec)						2.27					3.50		3.30			

## Delay, Queue Length, and Level of Service

Flow Rate, v (veh/h)						5					18					
Capacity, c (veh/h)						705					189					
v/c Ratio						0.01					0.10					
95% Queue Length, Q <sub>95</sub> (veh)						0.0					0.3					
Control Delay (s/veh)						10.1					26.0					
Level of Service, LOS						B					D					
Approach Delay (s/veh)					0.1				26.0							
Approach LOS									D							

# HCS 2010 Two-Way Stop-Control Report

General Information		Site Information	
Analyst	JJB & A	Intersection	S. Washington/E. River
Agency/Co.	JJB & A	Jurisdiction	Batavia
Date Performed	11/16/2016	East/West Street	E. Wilson
Analysis Year	2016	North/South Street	S. Washington
Time Analyzed	2024 Total Traffic PM Pk	Peak Hour Factor	0.95
Intersection Orientation	East-West	Analysis Time Period (hrs)	0.25
Project Description	One N Washington Place		

## Lanes

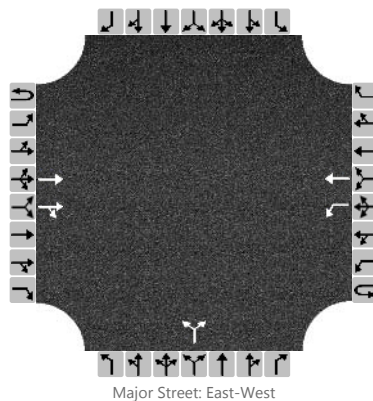

## Vehicle Volumes and Adjustments

Approach	Eastbound				Westbound				Northbound				Southbound			
	U	L	T	R	U	L	T	R	U	L	T	R	U	L	T	R
Movement	1U	1	2	3	4U	4	5	6		7	8	9		10	11	12
Priority																
Number of Lanes	0	0	2	0	0	1	1	0		0	0	0		0	0	0
Configuration			T	TR		L	T				LR					
Volume, V (veh/h)			695	19		10	955			6		11				
Percent Heavy Vehicles (%)						1				0		0				
Proportion Time Blocked																
Percent Grade (%)									0							
Right Turn Channelized	No				No				No				No			
Median Type/Storage	Undivided															

## Critical and Follow-up Headways

Base Critical Headway (sec)						4.1					7.5		6.9			
Critical Headway (sec)						4.12					6.80		6.90			
Base Follow-Up Headway (sec)						2.2					3.5		3.3			
Follow-Up Headway (sec)						2.21					3.50		3.30			

## Delay, Queue Length, and Level of Service

Flow Rate, v (veh/h)						11					18					
Capacity, c (veh/h)						859					182					
v/c Ratio						0.01					0.10					
95% Queue Length, Q <sub>95</sub> (veh)						0.0					0.3					
Control Delay (s/veh)						9.2					27.0					
Level of Service, LOS						A					D					
Approach Delay (s/veh)					0.1				27.0							
Approach LOS									D							

Lanes, Volumes, Timings  
N. Washington & E. Wilson

11/16/2016

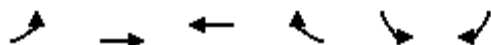

Lane Group	EBL	EBT	WBT	WBR	SBL	SBR
Lane Configurations						
Traffic Volume (vph)	251	616	526	90	47	236
Future Volume (vph)	251	616	526	90	47	236
Ideal Flow (vphpl)	1900	1900	1900	1900	1900	1900
Lane Width (ft)	11	11	11	11	11	11
Storage Length (ft)	0			65	125	125
Storage Lanes	1			1	1	0
Taper Length (ft)	100				140	
Lane Util. Factor	1.00	1.00	1.00	1.00	1.00	1.00
Ped Bike Factor	1.00			0.97	1.00	
Fr <sub>t</sub>				0.850		0.850
Fl <sub>t</sub> Protected	0.950				0.950	
Satd. Flow (prot)	1616	1701	1701	1446	1662	1487
Fl <sub>t</sub> Permitted	0.368				0.950	
Satd. Flow (perm)	624	1701	1701	1405	1657	1487
Right Turn on Red				Yes		Yes
Satd. Flow (RTOR)				75		248
Link Speed (mph)		25	25		30	
Link Distance (ft)		112	341		418	
Travel Time (s)		3.1	9.3		9.5	
Confl. Peds. (#/hr)	3			3	1	
Peak Hour Factor	0.95	0.95	0.95	0.95	0.95	0.95
Heavy Vehicles (%)	8%	8%	8%	8%	5%	5%
Adj. Flow (vph)	264	648	554	95	49	248
Shared Lane Traffic (%)						
Lane Group Flow (vph)	264	648	554	95	49	248
Turn Type	pm+pt	NA	NA	Perm	Perm	Perm
Protected Phases	5	2	6			
Permitted Phases	2			6	4	4
Detector Phase	5	2	6	6	4	4
Switch Phase						
Minimum Initial (s)	1.5	5.0	5.0	5.0	5.0	5.0
Minimum Split (s)	6.0	22.5	22.5	22.5	14.0	14.0
Total Split (s)	6.0	81.0	75.0	75.0	19.0	19.0
Total Split (%)	6.0%	81.0%	75.0%	75.0%	19.0%	19.0%
Maximum Green (s)	1.5	76.5	70.5	70.5	14.5	14.5
Yellow Time (s)	3.5	3.5	3.5	3.5	3.5	3.5
All-Red Time (s)	1.0	1.0	1.0	1.0	1.0	1.0
Lost Time Adjust (s)	0.0	0.0	0.0	0.0	0.0	0.0
Total Lost Time (s)	4.5	4.5	4.5	4.5	4.5	4.5
Lead/Lag	Lead		Lag	Lag		
Lead-Lag Optimize?	Yes		Yes	Yes		
Vehicle Extension (s)	3.0	3.0	3.0	3.0	3.0	3.0
Recall Mode	None	C-Min	C-Min	C-Min	None	None
Walk Time (s)		7.0	7.0	7.0	7.0	7.0
Flash Dont Walk (s)		11.0	11.0	11.0	11.0	11.0
Pedestrian Calls (#/hr)		0	0	0	0	0
Act Effct Green (s)	81.9	81.9	68.1	68.1	9.1	9.1
Actuated g/C Ratio	0.82	0.82	0.68	0.68	0.09	0.09

Lanes, Volumes, Timings  
N. Washington & E. Wilson

11/16/2016



Lane Group	EBL	EBT	WBT	WBR	SBL	SBR
v/c Ratio	0.44	0.47	0.48	0.10	0.33	0.69
Control Delay	5.6	7.1	10.3	2.8	47.0	16.0
Queue Delay	0.0	1.0	0.0	0.0	0.0	0.0
Total Delay	5.6	8.1	10.3	2.8	47.0	16.0
LOS	A	A	B	A	D	B
Approach Delay		7.4	9.2		21.1	
Approach LOS		A	A		C	
Queue Length 50th (ft)	49	200	141	3	30	0
Queue Length 95th (ft)	m78	m234	298	26	62	70
Internal Link Dist (ft)		32	261		338	
Turn Bay Length (ft)				65	125	125
Base Capacity (vph)	603	1395	1215	1025	241	428
Starvation Cap Reductn	0	471	0	0	0	0
Spillback Cap Reductn	0	0	23	0	0	3
Storage Cap Reductn	0	0	0	0	0	0
Reduced v/c Ratio	0.44	0.70	0.46	0.09	0.20	0.58

Intersection Summary

Area Type: Other  
 Cycle Length: 100  
 Actuated Cycle Length: 100  
 Offset: 0 (0%), Referenced to phase 2:EBTL and 6:WBT, Start of Green  
 Natural Cycle: 60  
 Control Type: Actuated-Coordinated  
 Maximum v/c Ratio: 0.69  
 Intersection Signal Delay: 10.2  
 Intersection LOS: B  
 Intersection Capacity Utilization 57.0%  
 ICU Level of Service B  
 Analysis Period (min) 15  
 m Volume for 95th percentile queue is metered by upstream signal.

Splits and Phases: 10: E Wilson & N Washington (IL25)



Lanes, Volumes, Timings  
N. Washington & E. Wilson

11/16/2016



Lane Group	EBL	EBT	WBT	WBR	SBL	SBR
Lane Configurations						
Traffic Volume (vph)	236	470	672	74	89	293
Future Volume (vph)	236	470	672	74	89	293
Ideal Flow (vphpl)	1900	1900	1900	1900	1900	1900
Lane Width (ft)	11	11	11	11	11	11
Storage Length (ft)	0			65	125	125
Storage Lanes	1			1	1	0
Taper Length (ft)	100				140	
Lane Util. Factor	1.00	1.00	1.00	1.00	1.00	1.00
Ped Bike Factor				0.96	1.00	0.97
Frt				0.850		0.850
Flt Protected	0.950				0.950	
Satd. Flow (prot)	1728	1818	1818	1546	1728	1546
Flt Permitted	0.311				0.950	
Satd. Flow (perm)	566	1818	1818	1485	1721	1503
Right Turn on Red				Yes		Yes
Satd. Flow (RTOR)				24		308
Link Speed (mph)		25	25		30	
Link Distance (ft)		112	341		418	
Travel Time (s)		3.1	9.3		9.5	
Confl. Peds. (#/hr)	5			5	1	2
Peak Hour Factor	0.95	0.95	0.95	0.95	0.95	0.95
Heavy Vehicles (%)	1%	1%	1%	1%	1%	1%
Adj. Flow (vph)	248	495	707	78	94	308
Shared Lane Traffic (%)						
Lane Group Flow (vph)	248	495	707	78	94	308
Turn Type	pm+pt	NA	NA	Perm	Perm	Perm
Protected Phases	5	2	6			
Permitted Phases	2			6	4	4
Detector Phase	5	2	6	6	4	4
Switch Phase						
Minimum Initial (s)	1.5	5.0	5.0	5.0	5.0	5.0
Minimum Split (s)	6.0	22.5	22.5	22.5	14.0	14.0
Total Split (s)	18.0	103.0	85.0	85.0	37.0	37.0
Total Split (%)	12.9%	73.6%	60.7%	60.7%	26.4%	26.4%
Maximum Green (s)	13.5	98.5	80.5	80.5	32.5	32.5
Yellow Time (s)	3.5	3.5	3.5	3.5	3.5	3.5
All-Red Time (s)	1.0	1.0	1.0	1.0	1.0	1.0
Lost Time Adjust (s)	0.0	0.0	0.0	0.0	0.0	0.0
Total Lost Time (s)	4.5	4.5	4.5	4.5	4.5	4.5
Lead/Lag	Lead		Lag	Lag		
Lead-Lag Optimize?	Yes		Yes	Yes		
Vehicle Extension (s)	3.0	3.0	3.0	3.0	3.0	3.0
Recall Mode	None	C-Min	C-Min	C-Min	None	None
Walk Time (s)		7.0	7.0	7.0	7.0	7.0
Flash Dont Walk (s)		11.0	11.0	11.0	11.0	11.0
Pedestrian Calls (#/hr)		0	0	0	0	0
Act Effct Green (s)	117.9	117.9	104.0	104.0	13.1	13.1
Actuated g/C Ratio	0.84	0.84	0.74	0.74	0.09	0.09

Lanes, Volumes, Timings  
N. Washington & E. Wilson

11/16/2016



Lane Group	EBL	EBT	WBT	WBR	SBL	SBR
v/c Ratio	0.45	0.32	0.52	0.07	0.58	0.74
Control Delay	5.9	5.7	10.1	4.4	74.6	16.9
Queue Delay	1.0	1.3	0.5	0.0	0.0	0.3
Total Delay	6.9	6.9	10.6	4.4	74.6	17.2
LOS	A	A	B	A	E	B
Approach Delay		6.9	10.0		30.6	
Approach LOS		A	B		C	
Queue Length 50th (ft)	65	185	238	12	84	0
Queue Length 95th (ft)	m69	m139	416	33	139	93
Internal Link Dist (ft)		32	261		338	
Turn Bay Length (ft)				65	125	125
Base Capacity (vph)	588	1530	1350	1109	399	585
Starvation Cap Reductn	155	786	0	0	0	0
Spillback Cap Reductn	0	0	271	0	0	45
Storage Cap Reductn	0	0	0	0	0	0
Reduced v/c Ratio	0.57	0.67	0.66	0.07	0.24	0.57

Intersection Summary

Area Type: Other  
 Cycle Length: 140  
 Actuated Cycle Length: 140  
 Offset: 0 (0%), Referenced to phase 2:EBTL and 6:WBT, Start of Green  
 Natural Cycle: 60  
 Control Type: Actuated-Coordinated  
 Maximum v/c Ratio: 0.74  
 Intersection Signal Delay: 13.1  
 Intersection LOS: B  
 Intersection Capacity Utilization 65.3%  
 ICU Level of Service C  
 Analysis Period (min) 15  
 m Volume for 95th percentile queue is metered by upstream signal.

Splits and Phases: 10: E Wilson & N Washington (IL25)



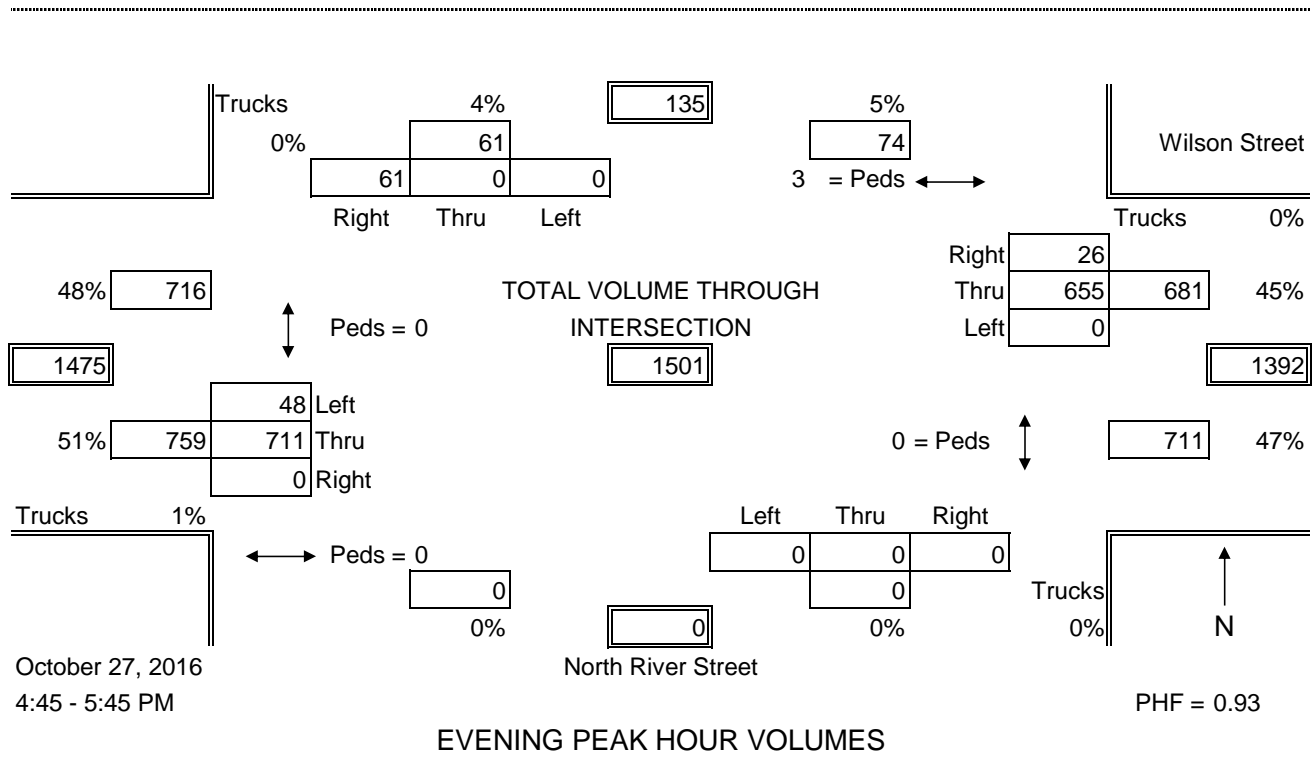
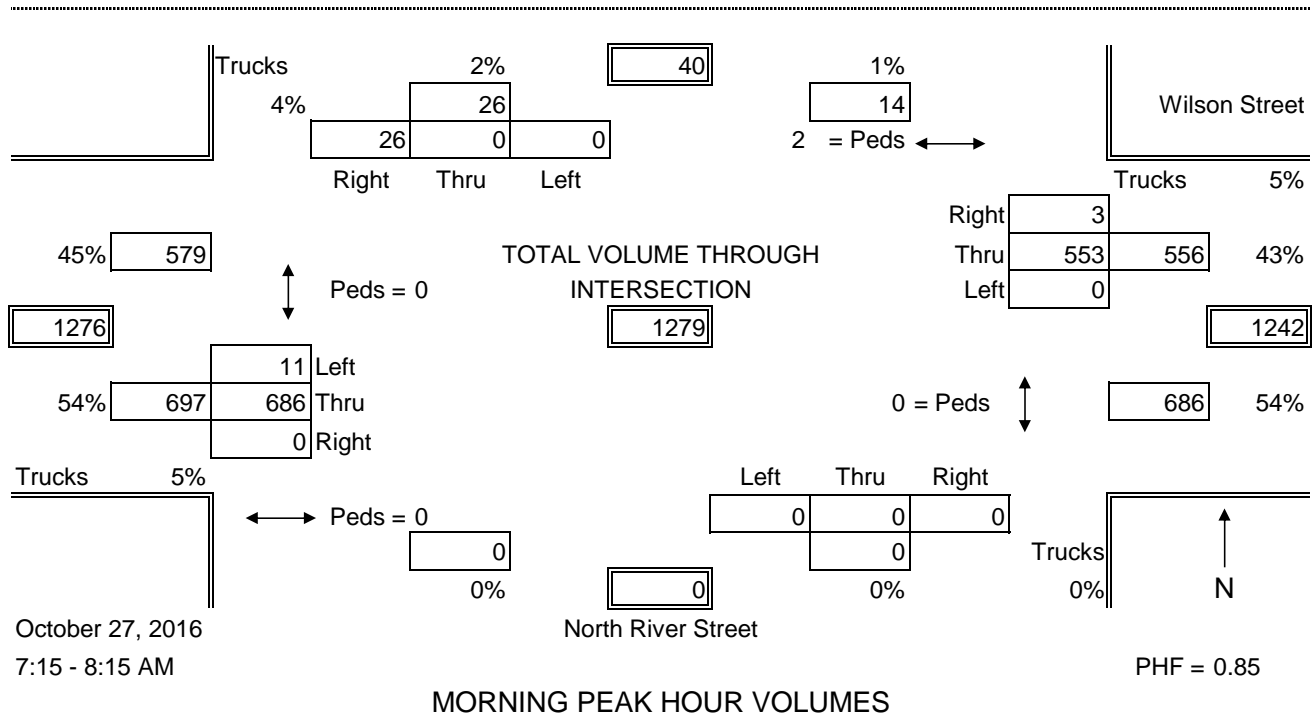

**EXISTING TRAFFIC VOLUMES**

Wilson Street  
North River Street  
System Peak Hours



**SUMMARY OF VEHICLE COUNTS  
MORNING PEAK PERIOD**

Observer: JAJ & PMT      Date: October 27, 2016      Day: Thursday      City: Batavia, Illinois  
 East-West Street: Wilson Street      North-South Street: North River Street

Time Begins A.M.	EASTBOUND				WESTBOUND				Total East West	NORTHBOUND				SOUTHBOUND				Total North South	Total	
	Left	Thru	Right	Total	Left	Thru	Right	Total		Left	Thru	Right	Total	Left	Thru	Right	Total			
7:00	0	143		143		67	0	67	210						4	4	4	214		
7:15	1	155		156		106	0	106	262						5	5	5	267		
7:30	3	179		182		107	1	108	290						3	3	3	293		
7:45	6	202		208		127	2	129	337						5	5	5	342		
8:00	1	150		151		213	0	213	364						13	13	13	377		
8:15	6	205		211		130	2	132	343						7	7	7	350		
8:30	9	163		172		94	4	98	270						2	2	2	272		
8:45	10	124		134		135	1	136	270						2	2	2	272		
<b>Total</b>	<b>36</b>	<b>1321</b>	<b>0</b>	<b>1357</b>	<b>0</b>	<b>979</b>	<b>10</b>	<b>989</b>	<b>2346</b>	<b>0</b>	<b>0</b>	<b>0</b>	<b>0</b>	<b>0</b>	<b>0</b>	<b>0</b>	<b>41</b>	<b>41</b>	<b>41</b>	<b>2387</b>
<b>Peak Hour</b>	<b>16</b>	<b>736</b>	<b>0</b>	<b>752</b>	<b>0</b>	<b>577</b>	<b>5</b>	<b>582</b>	<b>1334</b>	<b>0</b>	<b>0</b>	<b>0</b>	<b>0</b>	<b>0</b>	<b>0</b>	<b>0</b>	<b>28</b>	<b>28</b>	<b>28</b>	<b>1362</b>
<b>System Pk Hr</b>	<b>11</b>	<b>686</b>	<b>0</b>	<b>697</b>	<b>0</b>	<b>553</b>	<b>3</b>	<b>556</b>	<b>1253</b>	<b>0</b>	<b>0</b>	<b>0</b>	<b>0</b>	<b>0</b>	<b>0</b>	<b>0</b>	<b>26</b>	<b>26</b>	<b>26</b>	<b>1279</b>

Peak Hour Factor      0.90  
 7:15 - 8:15 System Peak Hour Factor      0.85

**SUMMARY OF VEHICLE COUNTS  
EVENING PEAK PERIOD**

Observer: JAJ & PMT      Date: October 27, 2016      Day: Thursday      City: Batavia, Illinois  
 East-West Street: Wilson Street      North-South Street: North River Street

Time Begins P.M.	EASTBOUND				WESTBOUND				Total East West	NORTHBOUND				SOUTHBOUND				Total North South	Total	
	Left	Thru	Right	Total	Left	Thru	Right	Total		Left	Thru	Right	Total	Left	Thru	Right	Total			
4:00	11	141		152		156	4	160	312						10	10	10	322		
4:15	4	132		136		156	4	160	296						4	4	4	300		
4:30	15	150		165		163	2	165	330						11	11	11	341		
4:45	15	163		178		163	5	168	346						14	14	14	360		
5:00	5	197		202		147	6	153	355						18	18	18	373		
5:15	18	176		194		189	3	192	386						16	16	16	402		
5:30	10	175		185		156	12	168	353						13	13	13	366		
5:45	20	158		178		149	4	153	331						18	18	18	349		
<b>Total</b>	<b>98</b>	<b>1292</b>	<b>0</b>	<b>1390</b>	<b>0</b>	<b>1279</b>	<b>40</b>	<b>1319</b>	<b>2709</b>	<b>0</b>	<b>0</b>	<b>0</b>	<b>0</b>	<b>0</b>	<b>0</b>	<b>0</b>	<b>104</b>	<b>104</b>	<b>104</b>	<b>2813</b>
<b>Peak Hour</b>	<b>48</b>	<b>711</b>	<b>0</b>	<b>759</b>	<b>0</b>	<b>655</b>	<b>26</b>	<b>681</b>	<b>1440</b>	<b>0</b>	<b>0</b>	<b>0</b>	<b>0</b>	<b>0</b>	<b>0</b>	<b>0</b>	<b>61</b>	<b>61</b>	<b>61</b>	<b>1501</b>
<b>System Pk Hr</b>	<b>48</b>	<b>711</b>	<b>0</b>	<b>759</b>	<b>0</b>	<b>655</b>	<b>26</b>	<b>681</b>	<b>1440</b>	<b>0</b>	<b>0</b>	<b>0</b>	<b>0</b>	<b>0</b>	<b>0</b>	<b>0</b>	<b>61</b>	<b>61</b>	<b>61</b>	<b>1501</b>

Peak Hour Factor      0.93  
 4:45 - 5:45 System Peak Hour Factor      0.93

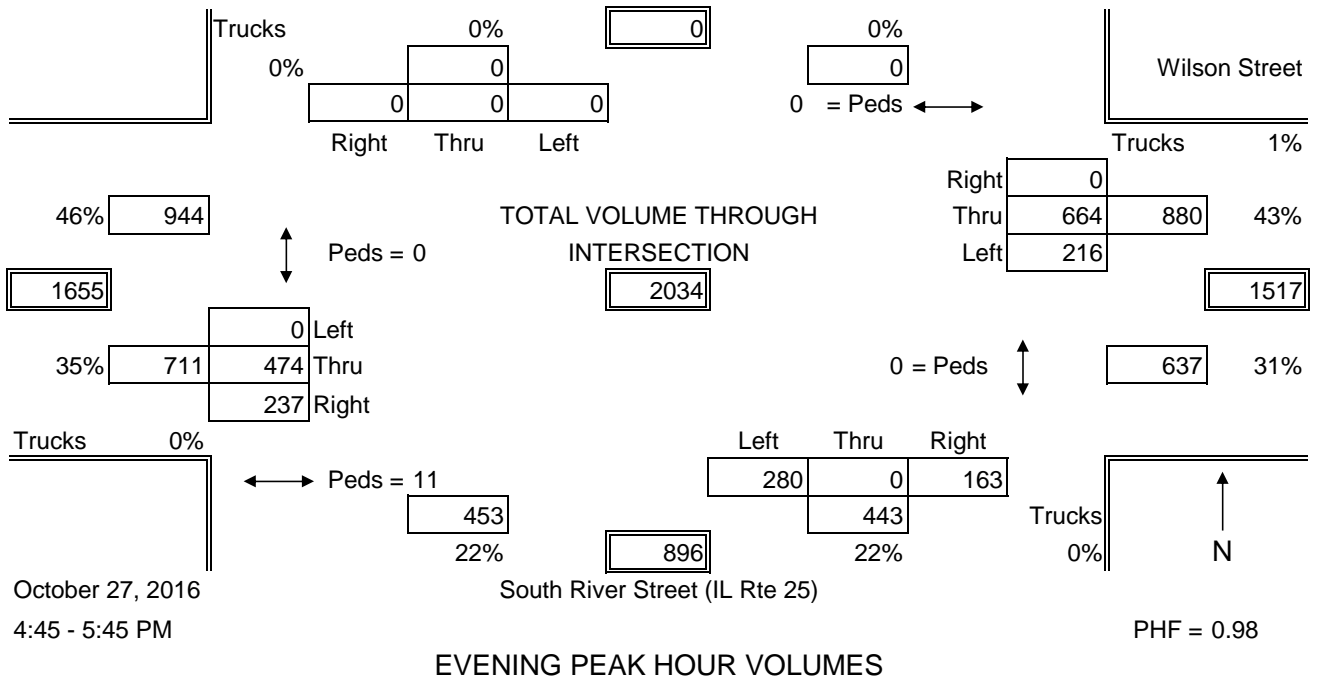
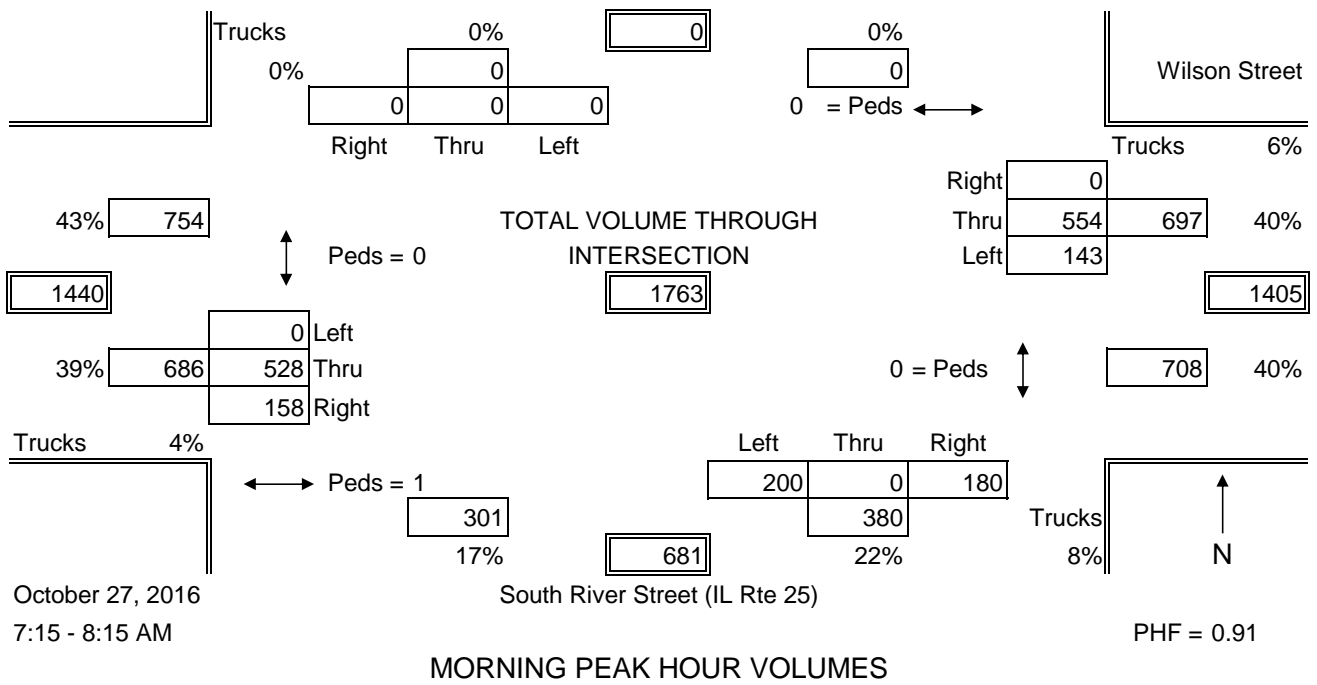

**EXISTING TRAFFIC VOLUMES**

Wilson Street  
 South River Street (IL Rte 25)  
 System Peak Hours

SUMMARY OF VEHICLE COUNTS  
MORNING PEAK PERIOD

Observer: JAJ & PMT      Date: October 27, 2016      Day: Thursday      City: Batavia, Illinois  
 East-West Street: Wilson Street      North-South Street: South River Street (IL Rte 25)

Time Begins A.M.	EASTBOUND				WESTBOUND				Total East West	NORTHBOUND				SOUTHBOUND				Total North South	Total
	Left	Thru	Right	Total	Left	Thru	Right	Total		Left	Thru	Right	Total	Left	Thru	Right	Total		
7:00		97	46	143	33	67		100	243	26		45	71				0	71	314
7:15		112	43	155	30	106		136	291	29		52	81				0	81	372
7:30		133	46	179	42	107		149	328	55		55	110				0	110	438
7:45		170	32	202	41	128		169	371	54		46	100				0	100	471
8:00		113	37	150	30	213		243	393	62		27	89				0	89	482
8:15		168	37	205	26	131		157	362	60		52	112				0	112	474
8:30		126	37	163	30	95		125	288	60		46	106				0	106	394
8:45		100	24	124	18	135		153	277	47		33	80				0	80	357
<b>Total</b>	0	1019	302	1321	250	982	0	1232	2553	393	0	356	749	0	0	0	0	749	3302
<b>Peak Hour</b>	0	584	152	736	139	579	0	718	1454	231	0	180	411	0	0	0	0	411	1865
<b>System Pk Hr</b>	0	528	158	686	143	554	0	697	1383	200	0	180	380	0	0	0	0	380	0.91

Peak Hour Factor      0.97  
 7:15 - 8:15 System Peak Hour Factor      0.91

SUMMARY OF VEHICLE COUNTS  
EVENING PEAK PERIOD

Observer: JAJ & PMT      Date: October 27, 2016      Day: Thursday      City: Batavia, Illinois  
 East-West Street: Wilson Street      North-South Street: South River Street (IL Rte 25)

Time Begins P.M.	EASTBOUND				WESTBOUND				Total East West	NORTHBOUND				SOUTHBOUND				Total North South	Total
	Left	Thru	Right	Total	Left	Thru	Right	Total		Left	Thru	Right	Total	Left	Thru	Right	Total		
4:00		90	51	141	52	160		212	353	79		38	117				0	117	470
4:15		81	51	132	54	158		212	344	64		35	99				0	99	443
4:30		106	44	150	47	163		210	360	79		44	123				0	123	483
4:45		112	51	163	57	163		220	383	70		40	110				0	110	493
5:00		138	59	197	51	148		199	396	77		47	124				0	124	520
5:15		110	66	176	47	191		238	414	57		34	91				0	91	505
5:30		114	61	175	61	162		223	398	76		42	118				0	118	516
5:45		108	50	158	41	153		194	352	47		29	76				0	76	428
<b>Total</b>	0	859	433	1292	410	1298	0	1708	3000	549	0	309	858	0	0	0	0	858	3858
<b>Peak Hour</b>	0	474	237	711	216	664	0	880	1591	280	0	163	443	0	0	0	0	443	2034
<b>System Pk Hr</b>	0	474	237	711	216	664	0	880	1591	280	0	163	443	0	0	0	0	443	2034

Peak Hour Factor      0.98  
 7:15 - 8:15 System Peak Hour Factor      0.98

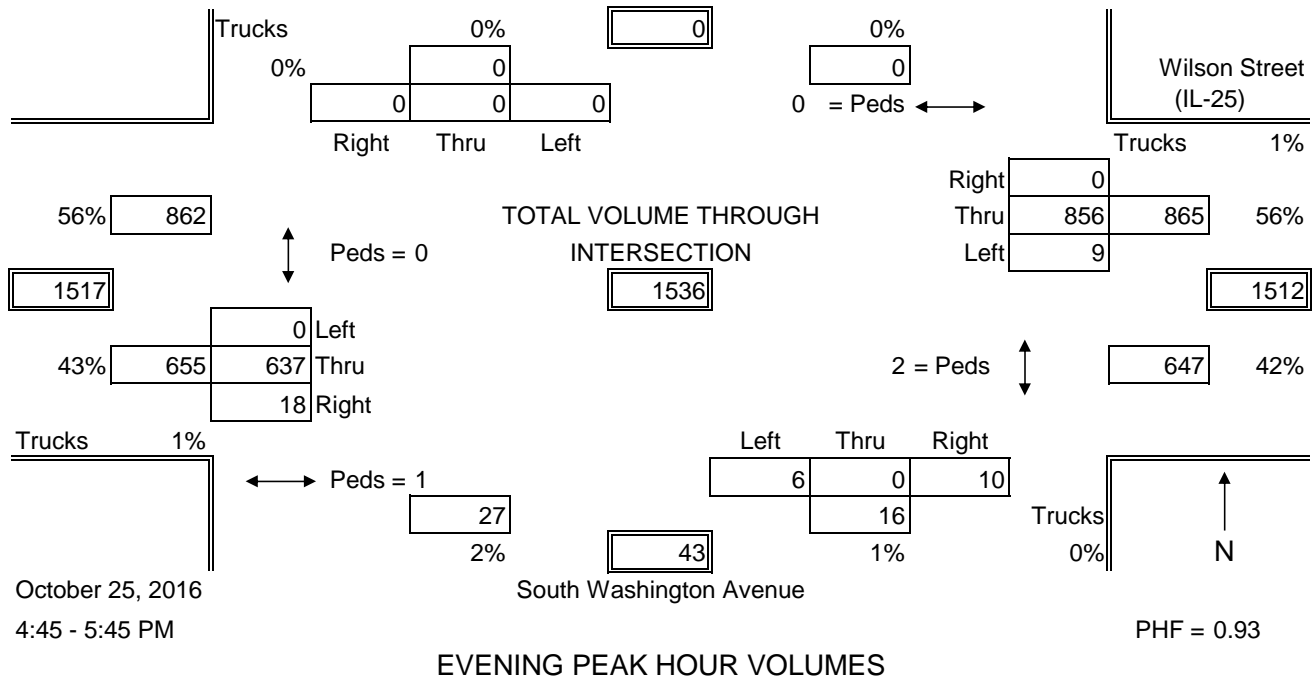
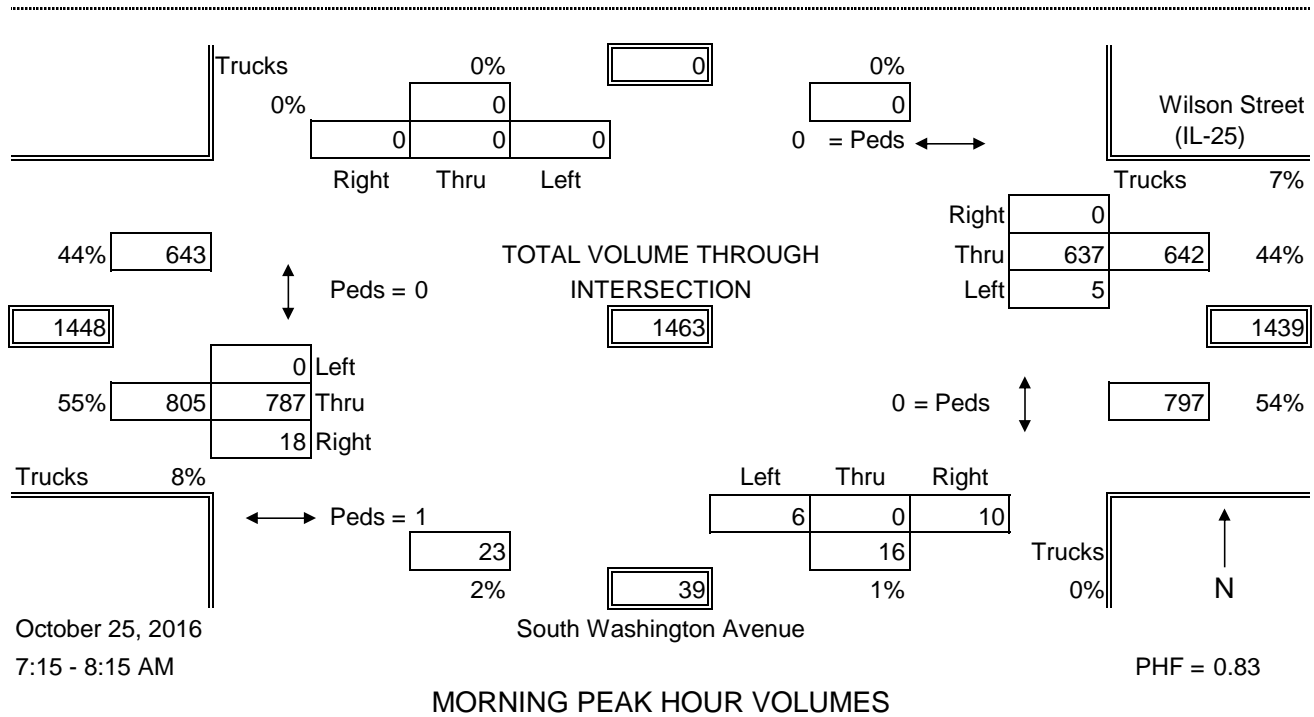

**EXISTING TRAFFIC VOLUMES**

Wilson Street  
South Washington Avenue  
System Peak Hour

SUMMARY OF VEHICLE COUNTS  
MORNING PEAK PERIOD

Observer: JAJ, PMT, SMP      Date: October 25, 2016      Day: Tuesday      City: Batavia, Illinois  
 East-West Street: Wilson Street      North-South Street: South Washington Avenue

Time Begins A.M.	EASTBOUND				WESTBOUND				Total East West	NORTHBOUND				SOUTHBOUND				Total North South	Total
	Left	Thru	Right	Total	Left	Thru	Right	Total		Left	Thru	Right	Total	Left	Thru	Right	Total		
7:00		168	0	168	2	150		152	320	0		2	2				0	2	322
7:15		191	5	196	0	239		239	435	3		5	8				0	8	443
7:30		228	9	237	3	146		149	386	3		2	5				0	5	391
7:45		215	4	219	2	145		147	366	0		2	2				0	2	368
8:00		153	0	153	0	107		107	260	0		1	1				0	1	261
8:15		166	0	166	0	126		126	292	0		4	4				0	4	296
8:30		121	1	122	1	145		146	268	2		1	3				0	3	271
8:45		126	1	127	0	179		179	306	2		1	3				0	3	309
<b>Total</b>	0	1368	20	1388	8	1237	0	1245	2633	10	0	18	28	0	0	0	0	28	2661
<b>Peak Hour</b>	0	802	18	820	7	680	0	687	1507	6	0	11	17	0	0	0	0	17	1524
<b>System Pk Hr</b>	0	787	18	805	5	637	0	642	1447	6	0	10	16	0	0	0	0	16	1463

Peak Hour Factor      0.86  
 7:15 - 8:15 System Peak Hour Factor      0.83

SUMMARY OF VEHICLE COUNTS  
EVENING PEAK PERIOD

Observer: JAJ, PMT, SMP      Date: October 25, 2016      Day: Tuesday      City: Batavia, Illinois  
 East-West Street: Wilson Street      North-South Street: South Washington Avenue

Time Begins P.M.	EASTBOUND				WESTBOUND				Total East West	NORTHBOUND				SOUTHBOUND				Total North South	Total
	Left	Thru	Right	Total	Left	Thru	Right	Total		Left	Thru	Right	Total	Left	Thru	Right	Total		
4:00		161	4	165	4	199		203	368	3		1	4				0	4	372
4:15		159	2	161	4	182		186	347	0		1	1				0	1	348
4:30		156	2	158	1	223		224	382	1		3	4				0	4	386
4:45		145	2	147	3	210		213	360	1		2	3				0	3	363
5:00		159	7	166	2	216		218	384	1		3	4				0	4	388
5:15		156	6	162	2	205		207	369	2		3	5				0	5	374
5:30		177	3	180	2	225		227	407	2		2	4				0	4	411
5:45		147	6	153	4	237		241	394	0		1	1				0	1	395
<b>Total</b>	0	1260	32	1292	22	1697	0	1719	3011	10	0	16	26	0	0	0	0	26	3037
<b>Peak Hour</b>	0	639	22	661	10	883	0	893	1554	5	0	9	14	0	0	0	0	14	1568
<b>System Pk Hr</b>	0	637	18	655	9	856	0	865	1520	6	0	10	16	0	0	0	0	16	1536

Peak Hour Factor      0.95  
 4:45 - 5:45 System Peak Hour Factor      0.93

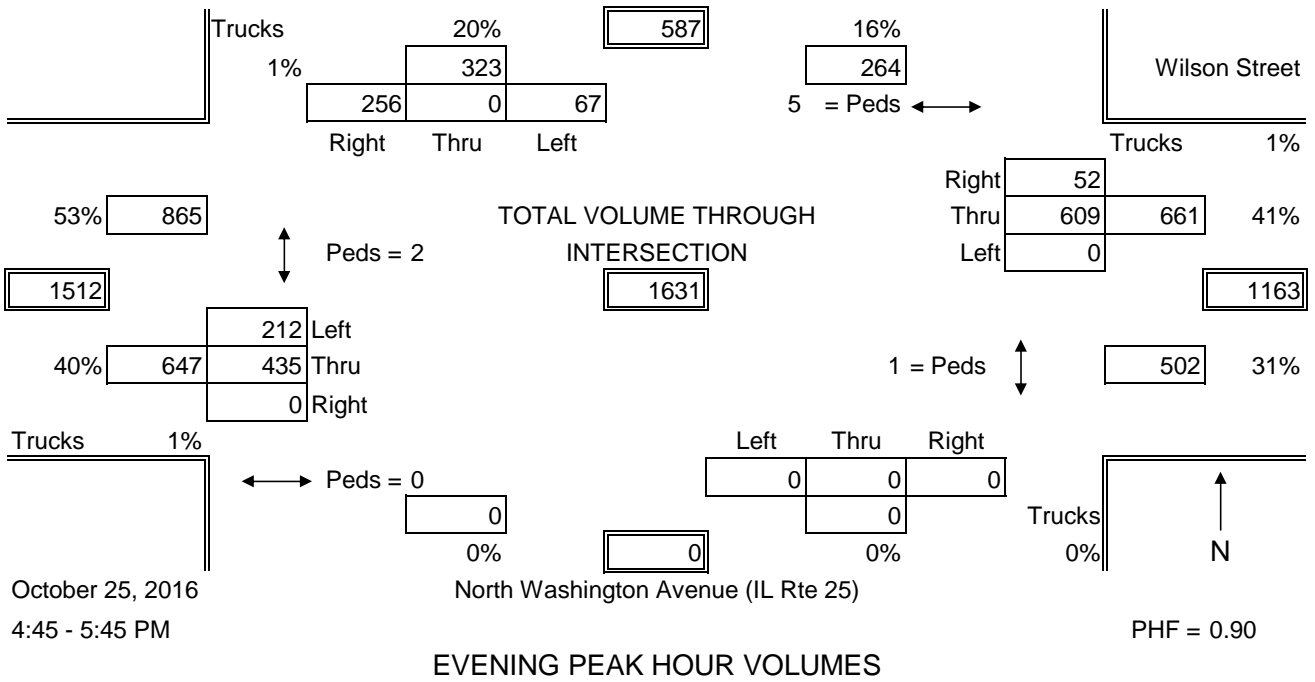
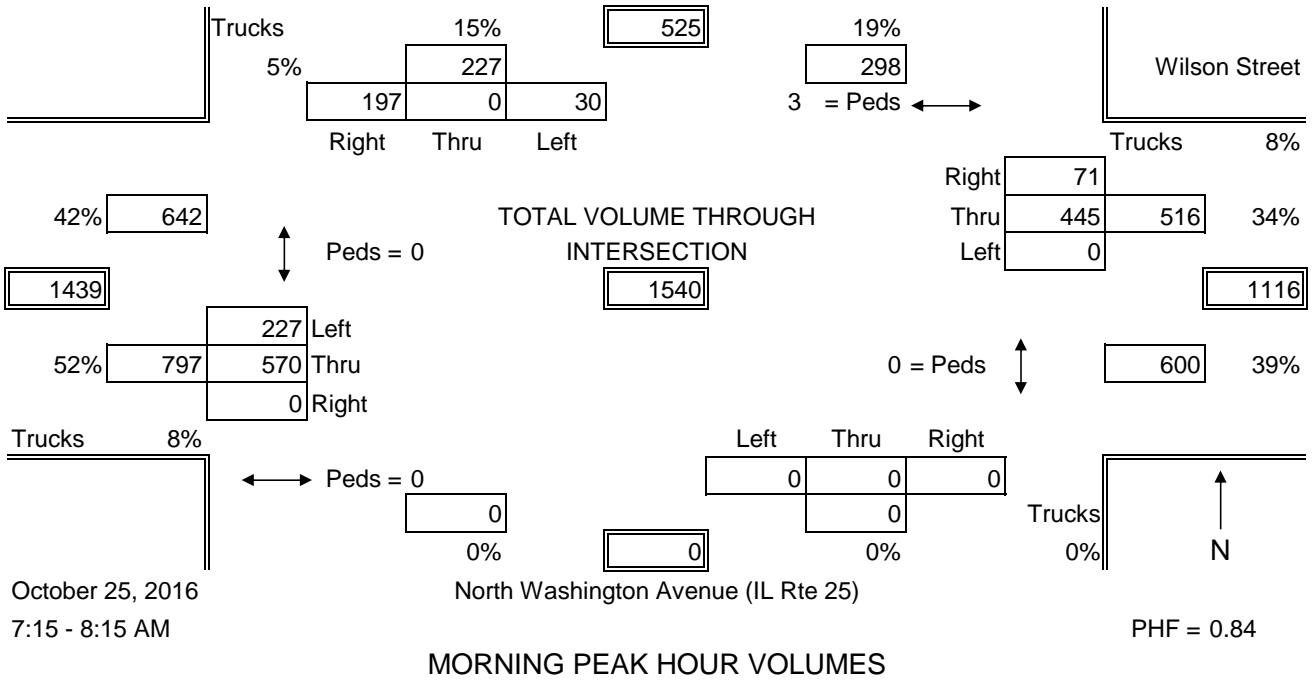

**EXISTING TRAFFIC VOLUMES**  
Wilson Street  
North Washington Avenue (IL Rte 25)  
System Peak Hour

SUMMARY OF VEHICLE COUNTS  
MORNING PEAK PERIOD

Observer: JAJ, PMT, SMP      Date: October 25, 2016      Day: Tuesday      City: Batavia, Illinois  
 East-West Street: Wilson Street      North-South Street: North Washington Avenue (IL Rte 25)

Time Begins A.M.	EASTBOUND				WESTBOUND				Total East West	NORTHBOUND				SOUTHBOUND				Total North South	Total
	Left	Thru	Right	Total	Left	Thru	Right	Total		Left	Thru	Right	Total	Left	Thru	Right	Total		
7:00	49	121		170		117	13	130	300				0	5		35	40	40	340
7:15	54	142		196		188	12	200	396				0	11		51	62	62	458
7:30	58	172		230		97	16	113	343				0	5		52	57	57	400
7:45	65	152		217		87	20	107	324				0	4		60	64	64	388
8:00	50	104		154		73	23	96	250				0	10		34	44	44	294
8:15	46	124		170		93	20	113	283				0	5		33	38	38	321
8:30	35	87		122		115	22	137	259				0	10		31	41	41	300
8:45	32	95		127		146	17	163	290				0	18		33	51	51	341
<b>Total</b>	<b>389</b>	<b>997</b>	<b>0</b>	<b>1386</b>	<b>0</b>	<b>916</b>	<b>143</b>	<b>1059</b>	<b>2445</b>	<b>0</b>	<b>0</b>	<b>0</b>	<b>0</b>	<b>68</b>	<b>0</b>	<b>329</b>	<b>397</b>	<b>397</b>	<b>2842</b>
<b>Peak Hour</b>	<b>226</b>	<b>587</b>	<b>0</b>	<b>813</b>	<b>0</b>	<b>489</b>	<b>61</b>	<b>550</b>	<b>1363</b>	<b>0</b>	<b>0</b>	<b>0</b>	<b>0</b>	<b>25</b>	<b>0</b>	<b>198</b>	<b>223</b>	<b>223</b>	<b>1586</b>
<b>System Pk Hr</b>	<b>227</b>	<b>570</b>	<b>0</b>	<b>797</b>	<b>0</b>	<b>445</b>	<b>71</b>	<b>516</b>	<b>1313</b>	<b>0</b>	<b>0</b>	<b>0</b>	<b>0</b>	<b>30</b>	<b>0</b>	<b>197</b>	<b>227</b>	<b>227</b>	<b>1540</b>

Peak Hour Factor      0.87  
 7:15 - 8:15 System Peak Hour Factor      0.84

SUMMARY OF VEHICLE COUNTS  
EVENING PEAK PERIOD

Observer: JAJ, PMT, SMP      Date: October 25, 2016      Day: Tuesday      City: Batavia, Illinois  
 East-West Street: Wilson Street      North-South Street: North Washington Avenue (IL Rte 25)

Time Begins P.M.	EASTBOUND				WESTBOUND				Total East West	NORTHBOUND				SOUTHBOUND				Total North South	Total
	Left	Thru	Right	Total	Left	Thru	Right	Total		Left	Thru	Right	Total	Left	Thru	Right	Total		
4:00	54	108		162		143	21	164	326				0	14		60	74	74	400
4:15	55	105		160		120	12	132	292				0	8		66	74	74	366
4:30	50	109		159		151	18	169	328				0	27		73	100	100	428
4:45	44	103		147		143	16	159	306				0	13		70	83	83	389
5:00	56	106		162		152	9	161	323				0	13		66	79	79	402
5:15	47	112		159		155	6	161	320				0	13		52	65	65	385
5:30	65	114		179		159	21	180	359				0	28		68	96	96	455
5:45	41	107		148		162	21	183	331				0	13		79	92	92	423
<b>Total</b>	<b>412</b>	<b>864</b>	<b>0</b>	<b>1276</b>	<b>0</b>	<b>1185</b>	<b>124</b>	<b>1309</b>	<b>2585</b>	<b>0</b>	<b>0</b>	<b>0</b>	<b>0</b>	<b>129</b>	<b>0</b>	<b>534</b>	<b>663</b>	<b>663</b>	<b>3248</b>
<b>Peak Hour</b>	<b>209</b>	<b>439</b>	<b>0</b>	<b>648</b>	<b>0</b>	<b>628</b>	<b>57</b>	<b>685</b>	<b>1333</b>	<b>0</b>	<b>0</b>	<b>0</b>	<b>0</b>	<b>67</b>	<b>0</b>	<b>265</b>	<b>332</b>	<b>332</b>	<b>1665</b>
<b>System Pk Hr</b>	<b>212</b>	<b>435</b>	<b>0</b>	<b>647</b>	<b>0</b>	<b>609</b>	<b>52</b>	<b>661</b>	<b>1308</b>	<b>0</b>	<b>0</b>	<b>0</b>	<b>0</b>	<b>67</b>	<b>0</b>	<b>256</b>	<b>323</b>	<b>323</b>	<b>1631</b>

Peak Hour Factor      0.91  
 4:45 - 5:45 System Peak Hour Factor      0.90